

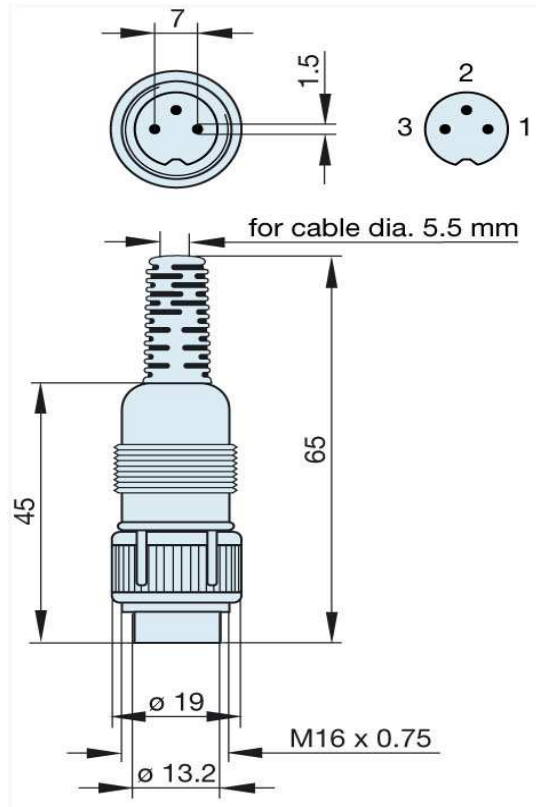

Product information
MAS 3100 UM grau/grey
931 068-117

Name	
MAS 3100 UM grau/grey	
	
plug with locking screw; solder joint	
Delivery informations	
Availability	available
Product description	
Type	MAS 3100 UM grau/grey
Order No.	931 068-117
Type of contact	male
Description	plug with locking screw; solder joint
Housing Color	grey
Number of contacts	3
Conductor size	$\leq 0.34 \text{ mm}^2$
Technical data	
LF output "Phone"	EN 60 130-09
Pole arrangement DIN	DIN 41 524
Rated current	4 A
Rated voltage	AC/DC 34 V
Cable diameter	5.5 mm
Type of termination	solder
Material	
Contact material	brass
Contact surface material	tin plated
Contact bearer material	PA 66/UL standard 94V-2
Housing material	PE
Environmental conditions	
Protection class (IEC 60529)	IP 30
Temperature range	-20 °C to +60 °C
Scope of delivery and accessories	
Packaging	industry package, box; individual parts not assembled, sorted

Picture
Drawing



The information published has been compiled as carefully as possible. It is subject to alteration without notice in technical as well as in price related/commercial respect.