



Product information

N6R AM 3

931 592-002

Name	
N6R AM 3	
	
Panel-mounted connector with contact bearer in the casing (monoblock design)	
Delivery informations	
Availability	available
Product description	
Description	Panel-mounted connector with contact bearer in the casing (monoblock design)
Type	N6R AM 3
Order No.	931 592-002
Type of contact	male
Number of contacts	6 + PE
Conductor size	max. 1.5 mm ²
Standard	DIN 43651
Housing Color	grey
Technical data	
Pin dimensions	1.6 mm
Rated voltage	AC/DC 250 V
Rated current	10 A
Contact resistance	<= 5 mOhm
Type of termination	crimp
Suitable cables	0.5 mm ² to 1.5 mm ²
Mounting	PG 11
Material	
Contact surface material	Ag
Contact bearer material	PET
Housing material	PET
Environmental conditions	
Protection class (IEC 60529)	IP 65
Temperature range	-40 °C to +90 °C
Packaging unit	
Packaging unit	10 pieces
Scope of delivery and accessories	
Scope of delivery	1 panel-mounted connector with O-Ring in polythene bag with assembly instructions
Accessories to order separately	can be plugged into N6R FF, N6R FF R, N6R EF; coding NC 6, order no. 831 002-011 protective cover SHK 1, order no. 733 849-011 contacts: RSC 162



Picture
Drawing

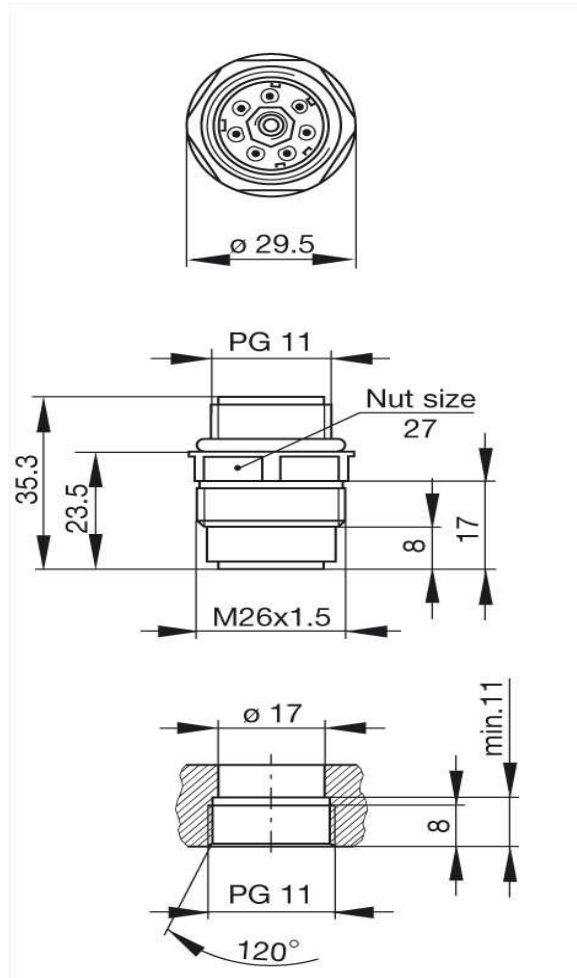

The information published has been compiled as carefully as possible. It is subject to alteration without notice in technical as well as in price related/commercial respect.