



**Product information**  
**GDSN 307 schwarz/black**  
**933 023-100**

<b>Name</b>	
GDSN 307 schwarz/black	
	
cable socket with central screw M 2.5 x 27	
<b>Delivery informations</b>	
<b>Availability</b>	available
<b>Product description</b>	
<b>Description</b>	cable socket with central screw M 2.5 x 27
<b>Type</b>	GDSN 307 schwarz/black
<b>Order No.</b>	933 023-100
<b>Other standard types</b>	grey housing, Order No. 933 023-106
<b>Number of contacts</b>	3 + PE
<b>Cable gland</b>	PG 7
<b>Conductor size</b>	max. 0.75 mm <sup>2</sup>
<b>Standard</b>	DIN EN 175 301-803-C
<b>Housing Color</b>	black
<b>Construction type</b>	C
<b>Technical data</b>	
<b>Pin dimensions</b>	2,8 mm x 0,5 mm, 3,6 mm x 0,5 mm
<b>Rated voltage</b>	AC/DC 250 V
<b>Rated current</b>	6 A
<b>Contact resistance</b>	<= 4 mOhm
<b>Type of termination</b>	screw
<b>Suitable cables</b>	4.5 mm to 6 mm
<b>Mounting</b>	central screw
<b>Material</b>	
<b>Contact surface material</b>	Sn
<b>Contact bearer material</b>	PA
<b>Housing material</b>	PA
<b>Environmental conditions</b>	
<b>Protection class (IEC 60529)</b>	IP 65
<b>Pollution severity</b>	3
<b>Temperature range</b>	-40 °C to +125 °C
<b>Inflammability class</b>	
<b>Housing</b>	94 HB
<b>Contact bearer</b>	94 V-2
<b>Approvals</b>	
<b>UR</b>	UR
<b>VDE</b>	VDE
<b>SEV</b>	SEV
<b>CSA</b>	CSA
<b>Packing unit</b>	
<b>Packaging unit</b>	200 pieces
<b>Scope of delivery and accessories</b>	
<b>Accessories to order separately</b>	(NBR) flat gasket GDSN 307-4, Order No. 730 176-002; (EPDM) flat gasket GDSN 307-5, Order No. 730 310-004

The information published has been compiled as carefully as possible. It is subject to alteration without notice in technical as well as in price related/commercial respect.



Picture  
Drawing

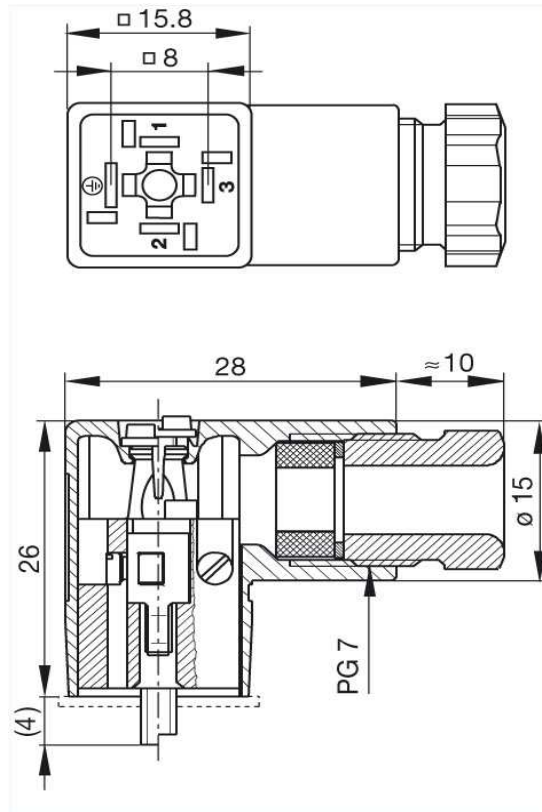

The information published has been compiled as carefully as possible. It is subject to alteration without notice in technical as well as in price related/commercial respect.