



**Product information**  
**ELWIST 5012 PG7**  
**933 167-100**

<b>Name</b>	
ELWIST 5012 PG7	
	
Angled cable plug, unassembled, strain relief by means of clamping cage	
<b>Delivery informations</b>	
<b>Availability</b>	available
<b>Product description</b>	
<b>Description</b>	Angled cable plug, unassembled, strain relief by means of clamping cage
<b>Type</b>	ELWIST 5012 PG7
<b>Order No.</b>	933 167-100
<b>Type of contact</b>	male
<b>Number of contacts</b>	5
<b>Cable gland</b>	PG 7
<b>Standard</b>	IEC 61076-2-101 (Ed. 1)/ IEC 60947-5-2
<b>Housing Color</b>	black
<b>Technical data</b>	
<b>Pin dimensions</b>	1 mm
<b>Rated voltage</b>	AC/DC 50 V
<b>Rated current</b>	4 A
<b>Type of termination</b>	screw
<b>Suitable cables</b>	diameter 4 mm to 6 mm, max. 0.75 mm <sup>2</sup>
<b>Material</b>	
<b>Contact material</b>	Cu Zn
<b>Contact surface material</b>	Sn
<b>Contact bearer material</b>	PA
<b>Housing material</b>	PA
<b>Coupling nut material</b>	Zn Al/Ni
<b>O-Ring</b>	NBR
<b>Environmental conditions</b>	
<b>Protection class (IEC 60529)</b>	IP 67
<b>Pollution severity</b>	3
<b>Temperature range</b>	-25 °C to +90 °C
<b>Inflammability class</b>	
<b>Housing</b>	94 V-2
<b>Contact bearer</b>	94 V-2
<b>Packing unit</b>	
<b>Packaging unit</b>	100 pieces



Picture  
Drawing

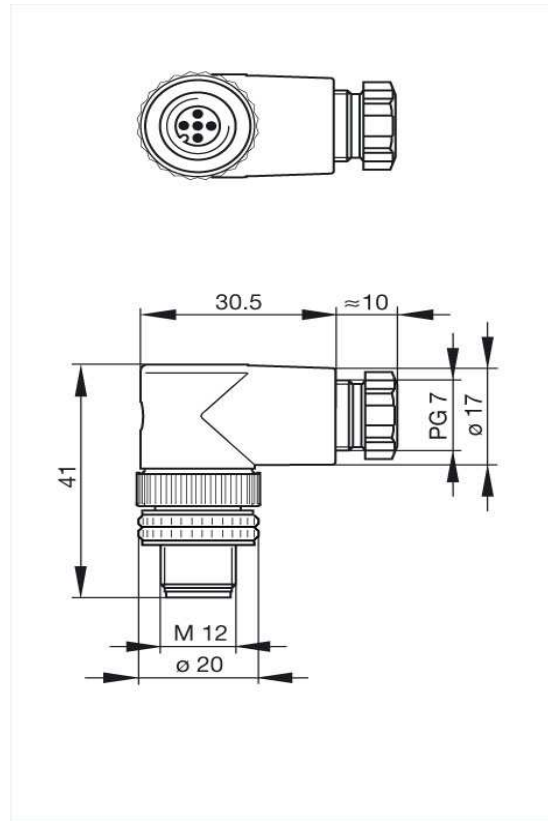

The information published has been compiled as carefully as possible. It is subject to alteration without notice in technical as well as in price related/commercial respect.