



**Product information**

**ELWIKA 4008 V**

**933 369-100**

<b>Name</b>	
ELWIKA 4008 V	
	
Angled cable socket, unassembled, strain relief by means of clamping cage	
<b>Delivery informations</b>	
<b>Availability</b>	available
<b>Product description</b>	
<b>Description</b>	Angled cable socket, unassembled, strain relief by means of clamping cage
<b>Type</b>	ELWIKA 4008 V
<b>Order No.</b>	933 369-100
<b>Type of contact</b>	female
<b>Number of contacts</b>	4
<b>Cable gland</b>	M 9.5 x 1
<b>Standard</b>	IEC 61076-2-101 (Ed. 1)/ IEC 60947-5-2
<b>Housing Color</b>	black
<b>Technical data</b>	
<b>Rated voltage</b>	AC/DC 30 V
<b>Rated current</b>	3 A (2 A at 0.14 mm <sup>2</sup> )
<b>Type of termination</b>	pin penetration
<b>Suitable cables</b>	diameter 4 mm to 5 mm / 0.14 mm <sup>2</sup> to 0.34 mm <sup>2</sup>
<b>Core insulation of connecting leads</b>	PVC, PETP, diameter 1.0 mm to 1.55 mm
<b>Material</b>	
<b>Contact material</b>	Cu Sn
<b>Contact surface material</b>	Au
<b>Contact bearer material</b>	PA
<b>Housing material</b>	PA
<b>Coupling nut material</b>	Zn Al/Ni
<b>O-Ring</b>	Viton / NBR
<b>Environmental conditions</b>	
<b>Protection class (IEC 60529)</b>	IP 67
<b>Pollution severity</b>	3
<b>Temperature range</b>	-25 °C to +70 °C
<b>Inflammability class</b>	
<b>Housing</b>	94 V-2
<b>Contact bearer</b>	94 V-2
<b>Packing unit</b>	
<b>Packaging unit</b>	100 pieces



Picture  
Drawing

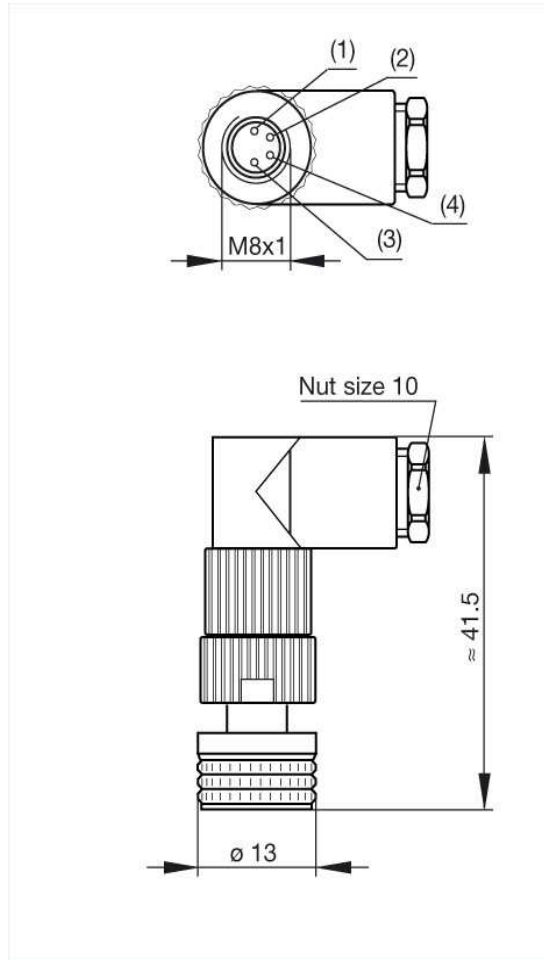

The information published has been compiled as carefully as possible. It is subject to alteration without notice in technical as well as in price related/commercial respect.