



Product information
GDM 3016 grau/grey
934 395-106

Name	
GDM 3016 grau/grey	
	
cable socket with central screw M 3 x 35	
Delivery informations	
Availability	available
Product description	
Description	cable socket with central screw M 3 x 35
Type	GDM 3016 grau/grey
Order No.	934 395-106
Other standard types	black housing, Order no. 934 395-100
Number of contacts	3 + PE
Cable gland	M 16
Conductor size	max. 1.5 mm ²
Standard	DIN EN 175 301-803-A
Housing Color	grau
Construction type	A
Technical data	
Pin dimensions	6.3 mm x 0.8 mm, 4.8 mm x 0.8 mm
Rated voltage	AC/DC 250 V
Rated current	16 A
Contact resistance	<= 4 mOhm
Type of termination	screw
Suitable cables	4.5 mm to 10 mm diameter
Mounting	central nut
Material	
Contact surface material	Sn
Contact bearer material	PA
Housing material	PA
Environmental conditions	
Protection class (IEC 60529)	IP 65 (gasket necessary)
Pollution severity	3
Temperature range	-40 °C to +125 °C
Inflammability class	
Housing	94 HB
Contact bearer	94 HB
Approvals	
VDE	VDE
Packing unit	
Packaging unit	200 pieces
Scope of delivery and accessories	
Accessories to order separately	(NBR) flat gasket GDM 3-7, Order no. 730 801-002; (EPDM) flat gasket GDM 3-21, Order no. 731 739-004; profiled gasket GDM 3-16, Order no. 731 531-002; knurled screw GDM 3011-8, Order no. 732 574-001; stainless steel screw GDM 3011 RF-1, Order no. 734 363-001

The information published has been compiled as carefully as possible. It is subject to alteration without notice in technical as well as in price related/commercial respect.



Picture
Drawing

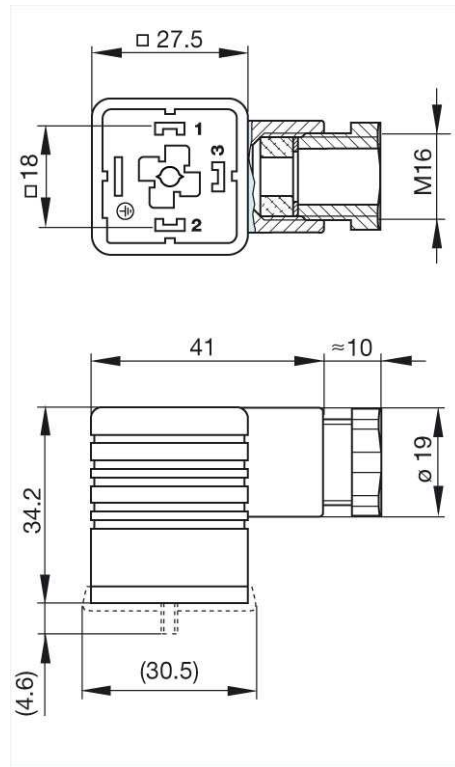

The information published has been compiled as carefully as possible. It is subject to alteration without notice in technical as well as in price related/commercial respect.