

SKINTOP® MS-M





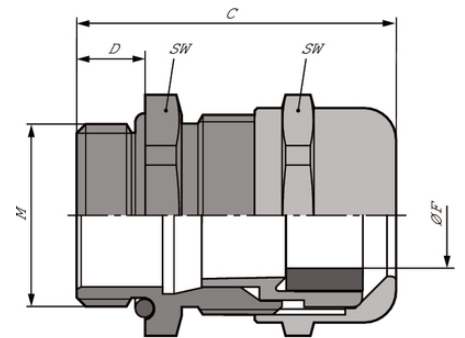
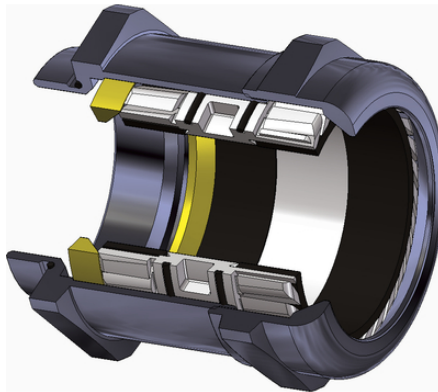

SKINTOP® MS-M, brass cable gland for cable diameters up to 98 mm, in areas where mechanical and chemical stability are critical

Info

SKINTOP® MS-M sizes 75 x 1.5 bis 110 x 2 with innovative double lamella basket. This simplifies the installation of cables with a large cross-section.

Now with IP69 approval! Proven to withstand demanding cleaning procedures for machinery and systems with high-pressure cleaners and hot water!



-  Variety of approval certifications
-  Temperature-resistant
-  Acid-resistant
-  Optimum strain relief
-  Mechanical resistance
-  Corrosion-resistant
-  Good chemical resistance

Last Update (02.05.2017)

©2017 Lapp Group - Technical changes reserved

Product Management www.lappkabel.de

You can find the current technical data in the corresponding data sheet.

PN 0456 / 02_03.16

SKINTOP® MS-M

Benefits

High functional reliability
Optimum strain relief
Wide, variable clamping ranges
For cable diameters up to 98 mm

Application range

In areas where mechanical and chemical stability are critical.
Chemical industry
Measurement, control and regulation technology
Machine and equipment manufacturing
Plant construction

Norm references / approvals

UL file no. E79903

Design

Metric connection thread according to DIN EN 60423
Basis for technical information DIN IEC 62444

Note

Counter nut to be used: SKINDICHT® SM-M
Refer to SKINTOP® metric accessories for suitable accessories

Technical Data

Classification:	ETIM 5.0 Class-ID: EC000441 ETIM 5.0 Class-Description: Cable gland
Caution:	Refer to T21 for the installation dimensions and tightening torques
Certifications:	IP 69 approval from size M75 x 1.5 pending. UL, CSA, DNV, VDE approval for sizes M90x2 and M110x2 pending.
Material:	Body: Nickel-plated brass Insert: Polyamide Sealing ring: CR O-ring: NBR
Protection rating:	IP 68 - 10 bar IP 69 (M12 - M63)
Temperature range:	dynamic -25°C up to +100°C static: -40°C to +100°C

Note

Photographs are not to scale and do not represent detailed images of the respective products.
Prices are net prices without VAT and surcharges. Sale to business customers only.

**SKINTOP® MS-M**

Article number	Article designation / size	Clamping range ØF (mm)	SW mm	Total length C (mm)	Thread length, D (mm)
SKINTOP® MS-M					
53112000	M 12 x 1,5	3 - 7	16	26.5	6.5
53112010	M 16 x 1,5	4.5 - 10	20	32	7
53112020	M 20 x 1,5	7 - 13	24	35.5	8
53112030	M 25 x 1,5	9 - 17	29	37.5	8
53112040	M 32 x 1,5	11 - 21	36	42.2	9
53112050	M 40 x 1,5	19 - 28	45	49.5	9
53112060	M 50 x 1,5	27 - 35	54	52	10
53112070	M 63 x 1,5	34 - 45	67	61.3	15
53112080	M 63 x 1,5 plus	44 - 55	75	65.5	15
53112510	M 75 x 1,5	58 - 68	95	105	15
53112512	M 90 x 2	66 - 78	115	136	20
53112514	M 110 x 2	86 - 98	135	154	25

Last Update (02.05.2017)

©2017 Lapp Group - Technical changes reserved

Product Management www.lappkabel.deYou can find the current technical data in the corresponding data sheet.
PN 0456 / 02_03.16