



HIRSCHMANN

A **BELDEN** BRAND

Antenna Guide

Wireless LAN Antennas of the BAT family



Electrooustic Ltd

www.electrooustic.co.uk

+44 (0)1908 307200

The naming of copyrighted trademarks in this manual, even when not specially indicated, should not be taken to mean that these names may be considered as free in the sense of the trademark and tradename protection law and hence that they may be freely used by anyone.

© 2015 Hirschmann Automation and Control GmbH

Manuals and software are protected by copyright. All rights reserved. The copying, reproduction, translation, conversion into any electronic medium or machine scannable form is not permitted, either in whole or in part. An exception is the preparation of a backup copy of the software for your own use. For devices with embedded software, the end-user license agreement on the enclosed CD/DVD applies.

The performance features described here are binding only if they have been expressly agreed when the contract was made. This document was produced by Hirschmann Automation and Control GmbH according to the best of the company's knowledge. Hirschmann reserves the right to change the contents of this document without prior notice. Hirschmann can give no guarantee in respect of the correctness or accuracy of the information in this document.

Hirschmann can accept no responsibility for damages, resulting from the use of the network components or the associated operating software. In addition, we refer to the conditions of use specified in the license contract.

You can get the latest version of this manual on the Internet at the Hirschmann product site (www.hirschmann.com).

Hirschmann Automation and Control GmbH
Stuttgarter Str. 45-51
72654 Neckartenzlingen
Germany
Tel.: +49 1805 141538

Contents

	Introduction	5
1	Current BAT portfolio	6
2	AP / Cable / Antenna assembly	8
3	Antenna Selection Criteria	9
4	External antennas	14
4.1	Legal regulations for operation external antennas	14
4.1.1	Relevant for use in the USA and in Canada:FCC compliant antennas	14
4.1.2	Relevant for use in Japan:	19
4.2	Omni-Directional Antennas	21
4.2.1	Omni-Directional Antenna for 2.4 GHz band	21
4.2.2	Omnidirectional antenna for 5 GHz band	22
4.2.3	Omnidirectional Antenna for 2.4 and 5 GHz band	24
4.2.4	Omni-directional dual-band antennae for MiMo for the 2.4 GHz and 5 GHz bands	30
4.2.5	Dual band Hemispherical Antenna for 2.4 and 5 GHz band	31
4.3	Sector Antennas	34
4.3.1	Directional antenna for the 2.4 GHz band with 8 dBi gain	34
4.3.2	Polarization-diversity antenna for 5 GHz band, linear	36
4.3.3	Sectoral MiMoantenna for 5 GHz band	38
4.4	Directional Antennas	40
4.4.1	Directional antenna for the 2.4 GHz band with 14 dBi gain	40
4.4.2	Directional antenna for 5 GHz band with 18 dBi gain	43
4.4.3	Directional antenna for 5 GHz band with a gain of 23 dBi	46
4.4.4	Directional antenna for 5 GHz band with 18 dBi gain	48
4.5	Radiating Cable Antennas (Leaky Cable)	51
4.5.1	Leaky Cable for 2.4 GHz; black	51

5	Cables/Adapter	55
A	Explanation of passive antennas in explosive hazard areas	61
B	Antenna diagrams	62
C	Index	66
D	Further Support	67

Introduction

Since 2004, Hirschmann Automation and Control GmbH has provided a continually expanding product portfolio relating to WLAN.

Our product portfolio comprises the following integral WLAN network elements:

- ▶ active devices such as access points, and clients
- ▶ passive components such as cables, antennas, and overvoltage protectors

With our product portfolio, we focus on a high industrial suitability. In order to improve our products, in particular with regard to vibration resistance, grounding behavior, impermeability and emission behavior, we have further developed our antenna portfolio.

You benefit from the following modifications of our antenna portfolio:

- ▶ All antennas comply with the IP65 degree of protection for a high industrial suitability. The sole exception to this is the BAT-ANT-N-14G-IP23 antenna.
- ▶ The emission behavior of the new antennas is more homogeneous, with improved transmit and receive power during operation.
- ▶ The new antennas, equipped with N sockets, allow you to connect the antennas easily and quickly with other cables and overvoltage protectors.
- ▶ The scope of delivery comprises a complete solution, with the antenna, 1 yard of cable, and the pigtail included. The complete solution allows you to immediately connect the antenna to the BAT-C, BAT-F, BAT-R, and BAT300-Rail.
- ▶ You obtain every antenna with mounting material which is vibration resistant, weatherproof, and sturdy.

We continually improve our product portfolio and include in the portfolio WLAN technology innovations. As a result, our portfolio is subject to short term changes. Check regularly for updates of our portfolio by visiting the Hirschmann product pages (www.hirschmann.com).

1 Current BAT portfolio

In the following you get an overview of our devices. You also obtain information on which WLAN standards the devices support.

- ▶ The products of the BAT300 family support the WLAN standards **IEEE 802.11a/b/g/h** and **802.11n** and can be operated with a gross data rate of up to 300 MBit/s.
- ▶ The products of the OpenBAT family support the **IEEE 802.11a/b/g/h/n** WLAN standards and can be operated with a gross data rate of up to 450 MBit/s.
- ▶ The BAT-C products support the WLAN standards **IEEE 802.11a/b/g/h/n** and can be operated with a gross data rate of up to 65 MBit/s.







BAT300-Rail	BAT300-F	BAT-F X2	BAT-F	BAT-R	BAT-C
The devices are supplied in metal enclosures for mounting on DIN rails in automation or vehicle applications.	The devices are supplied in IP65/67 metal housings. They are designed for field-level applications or harsh industrial environments.	The devices are supplied with stainless steel covers. They are designed for hazardous environments and are approved for ATEX zone 2.	The devices are supplied in a metal housing that can be fastened to DIN rails using automation technology. They provide impressive flexibility and high speeds.	The devices are supplied in a metal housing that can be fastened to DIN rails using automation technology. They provide impressive flexibility and high speeds.	The devices are supplied with an IP67 aluminum housing. They are suitable for use in an industrial environment.
BAT300-Rail	BAT300-F	BAT-F X2	BAT-F	BAT-R	BAT-C
					

Table 1: *BAT-Family: Overview*

For further information, see the installation user manual for the corresponding device.

2 AP / Cable / Antenna assembly

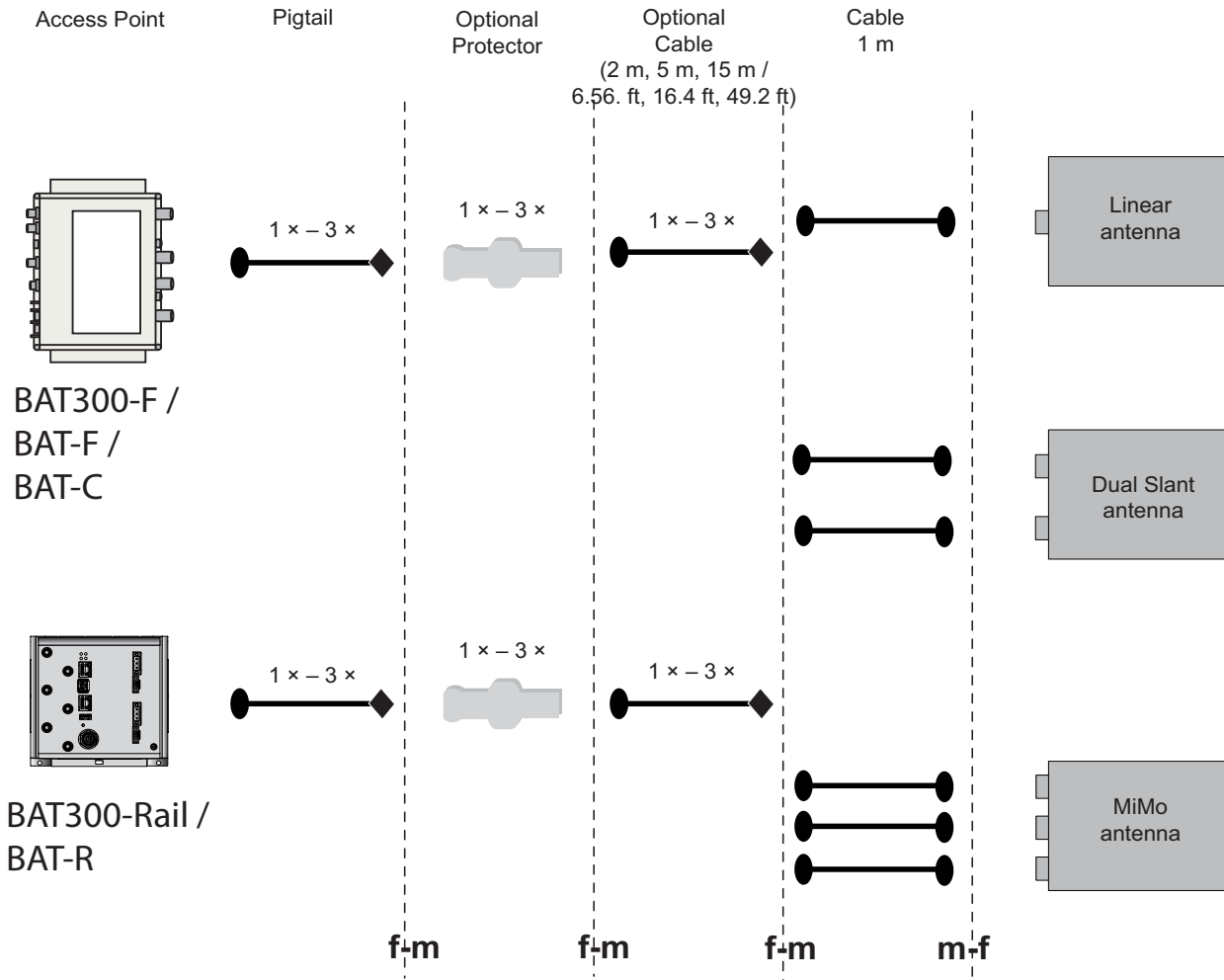

As every antenna set includes 1 yard of antenna cable and a pigtail, you have the option of immediately connecting both AP types BAT-F / BAT300-F/ BAT-C, and BAT-R/ BAT300-Rail to the antennas.

The BAT Protector can be screwed onto the BAT-F/ BAT300-F/ BAT-C directly, or be connected between two cables, as it is equipped with a plug and a socket.

3 Antenna Selection Criteria

- Take into account the national regulations that apply to the operation of antennas before considering any other criteria.

[See “Legal regulations for operation external antennas” on page 14.](#)

Note: Hirschmann recommends that you perform an on-site inspection and an analysis to prepare for the installation of a WLAN.

Typical antenna ranges, based on the frequency range and the antenna type:

- ▶ Frequency range: 2.4 GHz
 - Short range: up to 218 yards (200 m) with omnidirectional antennas.
 - Medium range: up to 0.62 miles (1 km) with sector antennas.
 - Long range: up to 3.11 miles (5 km) with directional antennas.
- ▶ Frequency range: 5 GHz
 - Short range: up to 328 yards (300 m) with omnidirectional antennas.
 - Medium range: up to 1.86 miles (3 km) with sector antennas.
 - Long range: up to 9.32 miles (15 km) with directional antennas.

The typical ranges provide orientation for the first-time antenna selection.

The actual antenna range depends on several factors such as output power, line of sight, and interference.

In the following table you find antenna descriptions. Together with the above described typical ranges, the descriptions provide orientation for the first-time antenna selection.





Art.-No	Antenna	Description	BAT-C	BAT300 family		OpenBAT family	
				BAT300-Rail	BAT300-F	BAT-R	BAT-F
943 981-002	BAT-ANT-N-6G-IP65	 Omnidirectional antenna for 2.4 GHz band	+++	+	+	+	+
943 981-003	BAT-ANT-N-5A-IP65	 Omnidirectional antenna for 5 GHz band	+++	+	+	+	+
942 110-001	BAT-ANT-N-3AGN-IP67	 Omnidirectional antenna for 2.4 GHz band and 5 GHz band	+++	-	+	-	+
942 047-001	BAT-ANT-N-3AGN-F	 Omnidirectional antenna for 2.4 GHz band and 5 GHz band	+++	-	+	-	+

Table 2: +++ very good; ++ good; + possible; – cannot be used; nr = not relevant
Whether an antenna is actually suitable depends on the application case.







Art.-No	Antenna	Description	BAT-C	BAT300 family		OpenBAT family	
				BAT300-Rail	BAT300-F	BAT-R	BAT-F
942 046-001	BAT-ANT-RSMA-2AGN-R	 Omnidirectional antenna for 2.4 GHz band and 5 GHz band	-	+	-	+	-
943 981-004	BAT-ANT-N-6ABG-IP65	 Hemispherical antenna for 2.4 GHz band and 5 GHz band	+++	+	+	+	+
943 981-005	BAT-ANT-N-14G-IP23	 Directional antenna for 2.4 GHz band with 14 dBi gain	-	+	+	+	+
943 981-006	BAT-ANT-N-18A-V-IP65	 Directional antenna for 5 GHz band with 18 dBi gain	-	++	++	++	++
943 981-007	BAT-ANT-N-23A-V-IP65	 Directional antenna for 5 GHz band with a high gain of 23 dBi	-	+	+	+	+
943 981-008	BAT-ANT-N-23A-VH-IP65	 Directional antenna for 5 GHz band with a high gain of 23 dBi	-	+++	+++	+++	+++

Table 2: +++ very good; ++ good; + possible; – cannot be used; nr = not relevant
Whether an antenna is actually suitable depends on the application case. (© 2015 307200)













Art.-No	Antenna	Description	BAT-C	BAT300 family		OpenBAT family	
				BAT300-Rail	BAT300-F	BAT-R	BAT-F
943 981-014	BAT-ANT-N-MiMo-18N-IP65	 Directional antenna for 5 GHz band with 18 dBi gain	-	+++	+++	+++	+++
943 981-009	BAT-ANT-N-8G-DS-IP65	 Polarization-diversity antenna for 2.4 GHz band, linear	-	++	++	++	++
943 981-010	BAT-ANT-N-9A-DS-IP65	 Polarization-diversity antenna for 5 GHz band, linear	-	++	++	++	++
943 981-012	BAT-ANT-N-MiMoDB-5N-IP65	 Omni-directional dual-band antenna for MiMo for the 2.4 GHz and 5 GHz bands	-	-	+++	+++	+++
943 981-013	BAT-ANT-N-MiMo5-9N-IP65	 Sectoral MiMoantenna for 5 GHz band	-	+++	+++	+++	+++
943 981-001	BAT-ANT-N-LC-G-50m-IP65	 Leaky wave conductor for 2.4 GHz, black, 50m	+++	+++	+++	+++	+++

Table 2: +++ very good; ++ good; + possible; – cannot be used; nr = not relevant
Whether an antenna is actually suitable depends on the application case.

Art.-No	Antenna	Description	BAT-C	BAT300 family		OpenBAT family	
				BAT300-Rail	BAT300-F	BAT-R	BAT-F
943 981-101	BAT-ANT-N-LC-G-100m-IP65	 Leaky wave conductor for 2.4 GHz, black, 100m	+++	+++	+++	+++	+++
943 903-373	BAT-ANT-Protector m-f	 Overvoltage Protector	+++	+++	+++	+++	+++
943 903-374	BAT-LAN-Protector IP68	 Surge Arrestor LAN/PoE	+++	+++	+++	+++	+++
943 903-360	BAT-Pigtail	 Adapter cable (N socket/RP-SMA plug)	nr	+++	-	+++	-
943 903-514	BAT-CLB-2 N m-f	 Antenna Cable N-Plug to N-Jack 2 m (6.56 ft)	+++	+++	+++	+++	+++
943 903-516	BAT-CLB-5 N m-f	 Antenna Cable N-Plug to N-Jack 5 m (16.40 ft)	+++	+++	+++	+++	+++
943 903-515	BAT-CLB-15 N m-f	 Antenna Cable N-Plug to N-Jack 15 m (49.21 ft)	+++	+++	+++	+++	+++

*Table 2: +++ very good; ++ good; + possible; – cannot be used; nr = not relevant
Whether an antenna is actually suitable depends on the application case.*

4 External antennas

This chapter is structured as follows:

- ▶ “Legal regulations for operation external antennas” on page 14
- ▶ “Omni-Directional Antennas” on page 21
- ▶ “Sector Antennas” on page 34
- ▶ “Directional Antennas” on page 40
- ▶ “Radiating Cable Antennas (Leaky Cable)” on page 51

4.1 Legal regulations for operation external antennas

You find additional information on approvals, certifications, and self-declarations in the Installation user manuals for the devices.

- Before operating the antennas, refer to the “Safety instructions” chapter in the Installation user manual for your device or devices.

4.1.1 Relevant for use in the USA and in Canada: FCC compliant antennas

For the operation of the OpenBAT devices in the USA and in Canada—characteristic value US for country approvals—you require a permit for the operation of antennas. If the operation of a specific antenna is legal depends on the frequency band and the WLAN module used. The following tables provide you an overview of the approved antennas.



Art.-No	Antennas operating with this device model:	Description	Permitted band of operation		
			2.4 GHz band	5.15 GHz ... 5.25 GHz band	5.725 GHz ... 5.825 GHz band
942 046-001	BAT-ANT-RSMA-2AGN-R	 Omnidirectional antenna for 2.4 GHz band and 5 GHz band	Yes	Yes	Yes
942 110-001	BAT-ANT-N-3AGN-IP67	 Omnidirectional antenna for 2.4 GHz band and 5 GHz band	Yes	Yes	Yes
943 981-012	BAT-ANT-N-MiMoDB-5N-IP65	 Omni-directional dual-band antenna for MiMo for the 2.4 GHz and 5 GHz bands	Yes	Yes	Yes

Table 3: *This table applies exclusively to OpenBAT devices that are labeled as follows:
Contains Transmitter Module
FCC ID: U99EWLAN1
IC: 4019A-EWLAN1*

Art.-No	Antennas operating with this device model:	Description	Permitted band of operation		
			2.4 GHz band	5.15 GHz ... 5.25 GHz band	5.725 GHz ... 5.825 GHz band
943 981-013	BAT-ANT-N-MiMo5-9N-IP65	 Sectoral MiMoantenna for 5 GHz band	No	Yes	Yes
943 981-009	BAT-ANT-N-8G-DS-IP65	 Polarization-diversity antenna for 2.4 GHz band, linear	Yes	No	No

*Table 3: This table applies exclusively to OpenBAT devices that are labeled as follows:
Contains Transmitter Module
FCC ID: U99EWLAN1
IC: 4019A-EWLAN1*

The use of antennas missing in this list is strictly prohibited. The required antenna impedance is 50 ohms.







Art.-No	Antennas operating with this device model:	Description	Permitted band of operation		
			2.4 GHz band	5.15 GHz ... 5.25 GHz band	5.725 GHz ... 5.825 GHz band
942 046-001	BAT-ANT-RSMA-2AGN-R	 Omnidirectional antenna for 2.4 GHz band and 5 GHz band	Yes	Yes	Yes
942 110-001	BAT-ANT-N-3AGN-IP67	 Omnidirectional antenna for 2.4 GHz band and 5 GHz band	Yes	Yes	Yes
943 981-012	BAT-ANT-N-MiMoDB-5N-IP65	 Omni-directional dual-band antenna for MiMo for the 2.4 GHz and 5 GHz bands	Yes	Yes	Yes
943 981-013	BAT-ANT-N-MiMo5-9N-IP65	 Sectoral MiMoantenna for 5 GHz band	No	Yes	Yes

Table 4: This table applies exclusively to OpenBAT devices that are labeled as follows:
Contains Transmitter Module
FCC ID: U99EWLAN2
IC: 4019A-EWLAN2

Art.-No	Antennas operating with this device model:	Description	Permitted band of operation		
			2.4 GHz band	5.15 GHz ... 5.25 GHz band	5.725 GHz ... 5.825 GHz band
943 981-009	BAT-ANT-N-8G-DS-IP65	 Polarization-diversity antenna for 2.4 GHz band, linear	Yes	No	No
943 981-014	BAT-ANT-N-MiMo-18N-IP65	 Directional antenna for 5 GHz band with 18 dBi gain	No	No	Yes







*Table 4: This table applies exclusively to OpenBAT devices that are labeled as follows:
Contains Transmitter Module
FCC ID: U99EWLAN2
IC: 4019A-EWLAN2*



The use of antennas missing in this list is strictly prohibited. The required antenna impedance is 50 ohms.

4.1.2 Relevant for use in Japan:

The following table applies to OpenBAT variants with the characteristic value JP (Japan) that are labeled as follows:

- ▶ "Contains MIC ID: 204-310014"
- ▶ "5GHz band: この製品は屋内においてのみ使用可能です"

Art.-No	Antennas operating with this device model:	Description	Permitted band of operation	
			2.4 GHz band	5 GHz band
942 110-001	BAT-ANT-N-3AGN-IP67	 Omnidirectional antenna for 2.4 GHz band and 5 GHz band	Ja	Ja
942 046-001	BAT-ANT-RSMA-2AGN-R	 Omnidirectional antenna for 2.4 GHz band and 5 GHz band	Ja	Ja
943 981-004	BAT-ANT-N-6ABG-IP65	 Hemispherical antenna for 2.4 GHz band and 5 GHz band	Ja	Ja
943 981-012	BAT-ANT-N-MiMoDB-5N-IP65	 Omni-directional dual-band antenna for MiMo for the 2.4 GHz and 5 GHz bands	Ja	Ja
943 981-009	BAT-ANT-N-8G-DS-IP65	 Polarization-diversity antenna for 2.4 GHz band, linear	Ja	Nein
943 981-010	BAT-ANT-N-9A-DS-IP65	 Polarization-diversity antenna for 5 GHz band, linear	Nein	Ja
943 981-002	BAT-ANT-N-6G-IP65	 Omnidirectional antenna for 2.4 GHz band	Ja	Nein

Art.-No	Antennas operating with this device model:	Description	Permitted band of operation	
			2.4 GHz band	5 GHz band
943 981-003	BAT-ANT-N-5A-IP65	 Omnidirectional antenna for 5 GHz band	Nein	Ja
943 981-013	BAT-ANT-N-MiMo5-9N-IP65	 Sectoral MiMo antenna for 5 GHz band	Nein	Ja

Using antennas that are not on this list is prohibited. The 5 GHz band is restricted to indoor usage.

4.2 Omni-Directional Antennas

4.2.1 Omni-Directional Antenna for 2.4 GHz band

■ **BAT-ANT-N-6G-IP65**

Order Number: 943 981-002



Radiation Pattern

Horizontal 2,400 MHz

Vertical 2,400 MHz

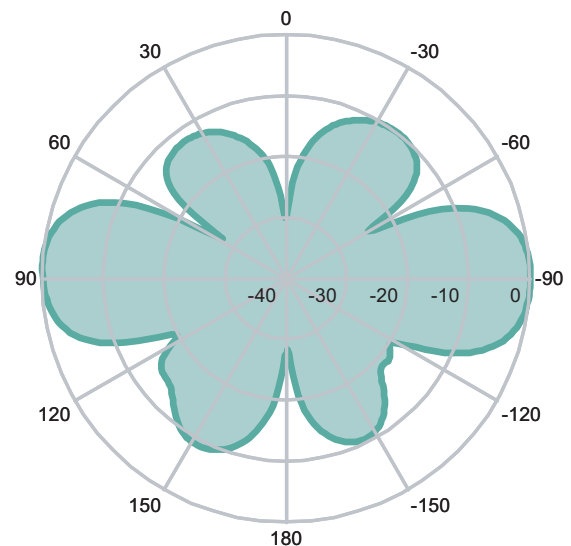
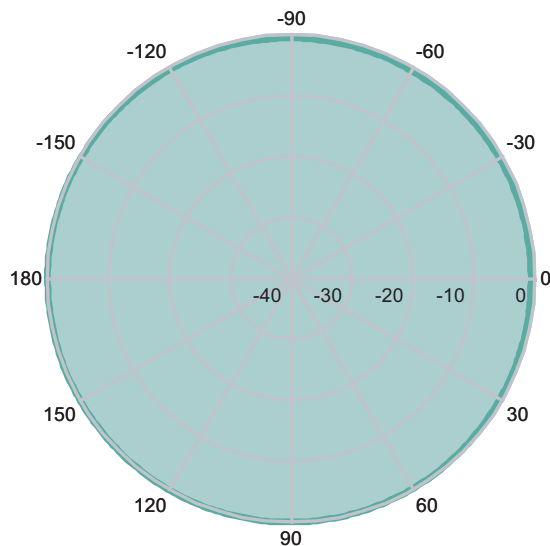

Frequency range	2400 MHz ... 2500 MHz
Gain	6.0 dBi
VSWR (voltage standing wave ratio)	< 1.8
Polarization	Linear, vertical
HPBW (half power bandwidth)	horizontal 360°
Downtilt	0°
Max. Power	25 W
Impedance	50 Ω
Connector	N female

Table 5: Electrical Specification

Temperature	-40 °F ... 176 °F (-40 °C ... +80 °C)
Radome color	Grey-white
Radome material	Fiber glass
Weight	0.75 lb (0.34 kg)
Dimensions	ø 0.87 in × 9.84 in (ø 22 mm × 250 mm)
Protection class	IP65

Table 6: Environmental & Mechanical Characteristics

3.28 ft (1 m) with N male connectors at both ends.
Pigtail, R-SMA male to N female
Mounting material

Table 7: Cable and Accessories

4.2.2 Omnidirectional antenna for 5 GHz band

■ BAT-ANT-N-5A-IP65

Order Number: 943 981-003



Radiation Pattern
horizontal 5470 MHz
vertical 5470 MHz

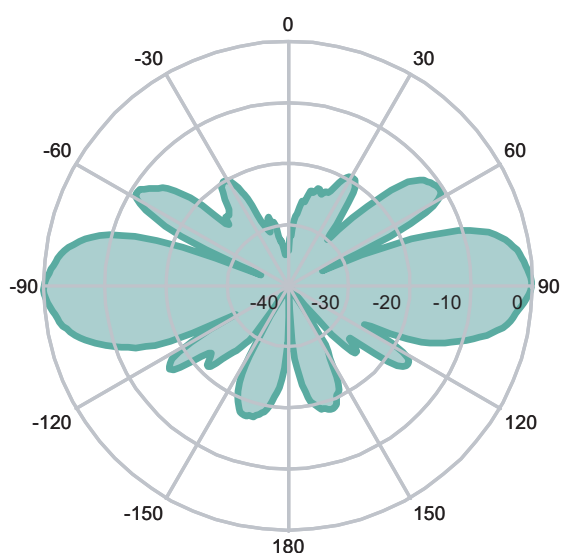
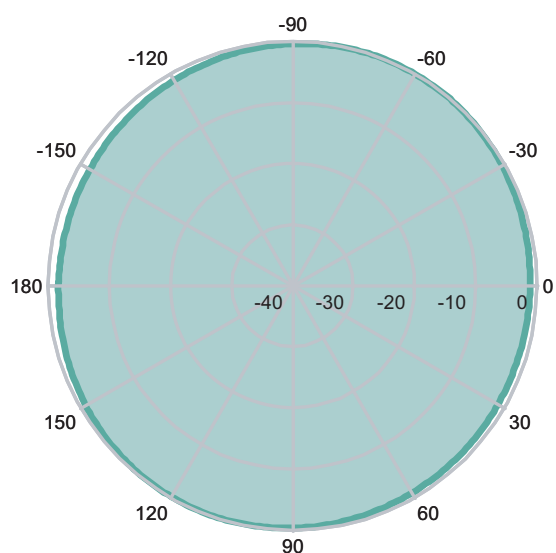

Frequency range	5150 MHz ... 5875 MHz
Gain	5 dBi
VSWR (voltage standing wave ratio)	1.5
Polarization	Linear, vertical
HPBW (half power bandwidth)	horizontal 360°
HPBW (half power bandwidth)	vertical 25°
Max. Power	6 W
Impedance	50 Ω
Connector	N female

Table 8: Electrical Specification

Temperature	-49 °F ... +158 °F (-45 °C ... +70 °C)
Radome color	Grey-white
Radome material	Polypropylene
Weight	0.66 lb (0.3 kg)
Dimensions	0.63 in. × 6.30 in. (16 mm × 160 mm)
Protection class	IP65

Table 9: Environmental & Mechanical Characteristics

3.28 ft (1 m) with N male connectors at both ends.
Pigtail, R-SMA male to N female
Mounting material

Table 10: Cable and Accessories

4.2.3 Omnidirectional Antenna for 2.4 and 5 GHz band

■ BAT-ANT-N-3AGN-IP67

Order number: 942 110-001 (10 pcs.)

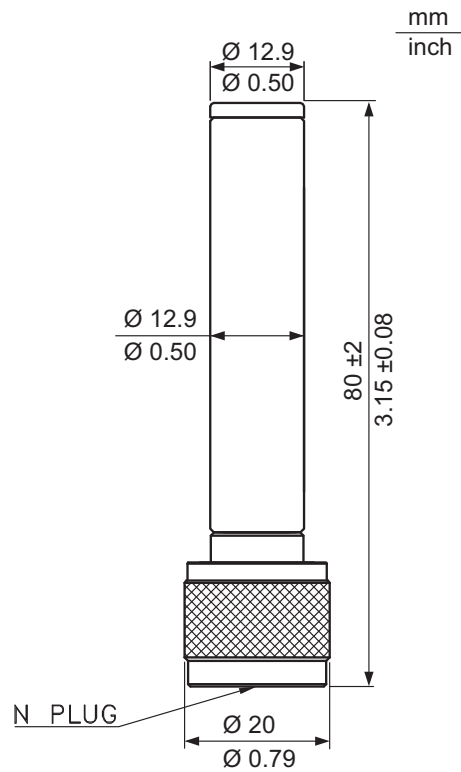

Radiation Pattern

horizontal
2.4 GHz

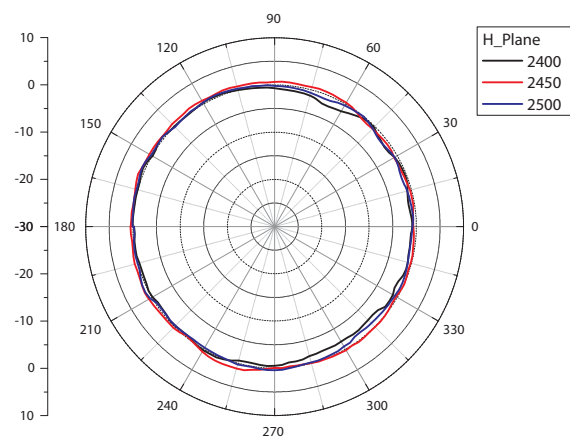

horizontal
5 GHz

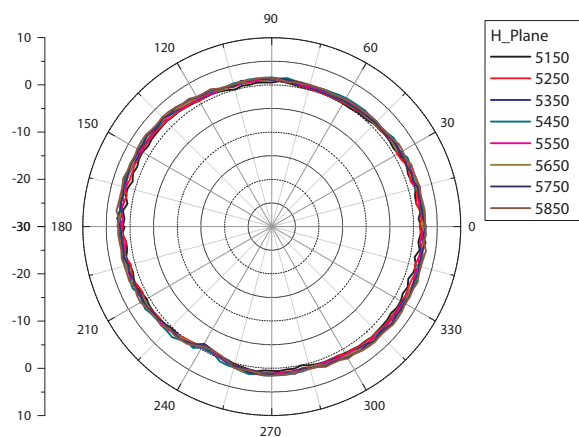

vertical
2.4 GHz

vertical
5 GHz

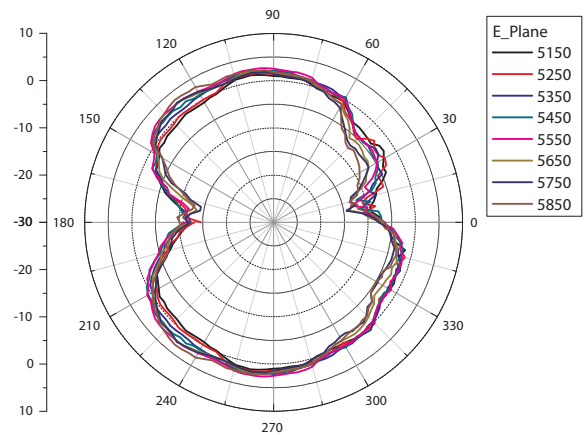
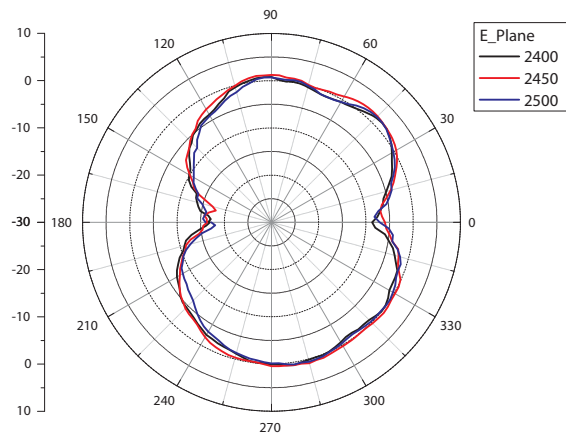

Frequency range	2400 MHz ... 2485 MHz	5150 MHz ... 5850 MHz
Gain	2.0 dBi	2.0 dBi
VSWR (voltage standing wave ratio)	≤2.0	
Polarization	Linear, vertical	
HPBW (half power bandwidth)	horizontal 360°	
HPBW (half power bandwidth)	vertical 30°	vertical 15°
Max. Power	2 W	
Impedance	50 Ω	
Connector	N-type male	

Table 11: Electrical Specification

Temperature	-40 °F ... +185 °F (-40 °C ... +85 °C)
Radome color	Black
Radome material	PC
Weight	1.23 oz (35 g)
Dimensions	0.79 in. × 3.15 in. (20 mm × 80 mm)
Protection class	IP65 / IP67

Table 12: Environmental & Mechanical Characteristics

■ BAT-ANT-N-3AGN-F

Order Number: 942 047-001 (10 pcs.)

The antenna is supplied with all BAT-F and BAT-C devices.

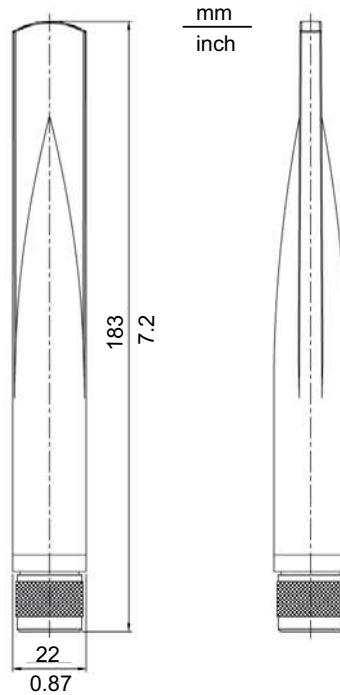

The antenna is directly screwed on the BAT.

Radiation Pattern

Horizontal 2,400 MHz

Horizontal 5,000 MHz

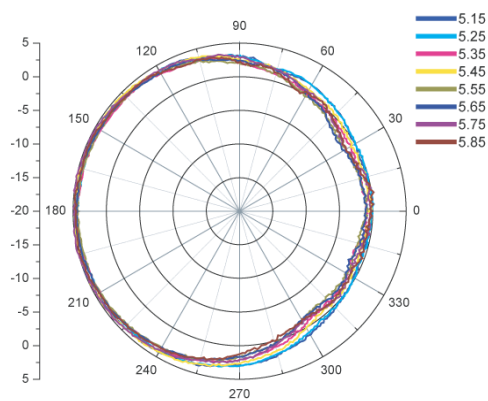
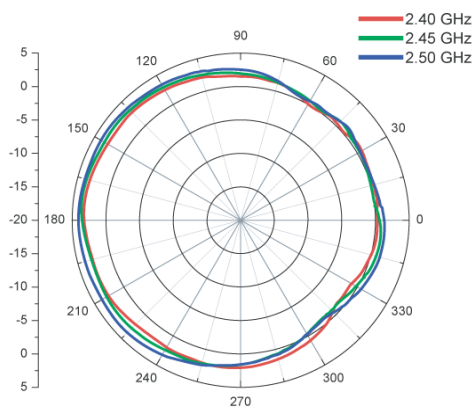

Vertical 2,400 MHz

Vertical 5,000 MHz

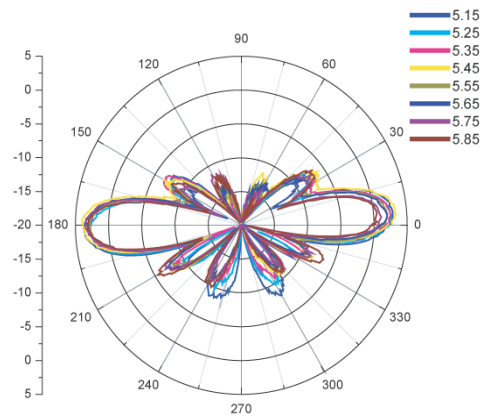
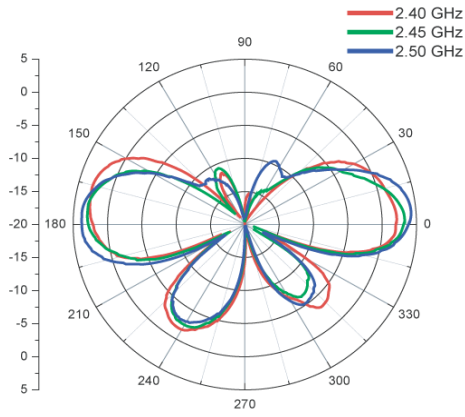

Frequency range	2400 MHz - 2500 MHz	5150 MHz ... 5875 MHz
Gain	2.5 dBi	5.0 dBi
VSWR (voltage standing wave ratio)	2.0	
Polarization	Linear, vertical	
HPBW (half power bandwidth)	horizontal 360°	
HPBW (half power bandwidth)	vertical 30°	vertical 15°
Max. Power	2 W	
Impedance	50 Ω	
Connector	N-type male	

Table 13: Electrical Specification

Temperature	-40 °F ... +158 °F (-40 °C ... +70 °C)
Radome color	Grey-white
Radome material	ABS
Weight	2.47 oz (70 g)
Dimensions	22 mm x 183 mm (0.87 in x 7.20 in)
Protection class	IP65

Table 14: Environmental & Mechanical Characteristics

Note: The antenna BAT-ANT-N-3AGN-F is specified solely for usage with the WLAN Client BAT-C in the regions EU, USA and Canada.

BAT-ANT-RSMA-2AGN-R

Order Number: 942 046-001 (10 pcs.)

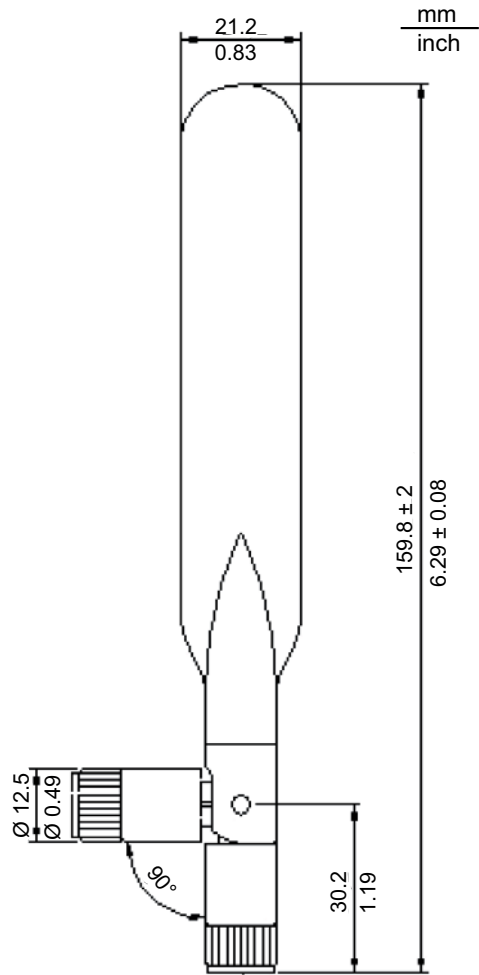

Radiation Pattern

horizontal 2450 MHz

vertical 2450 MHz

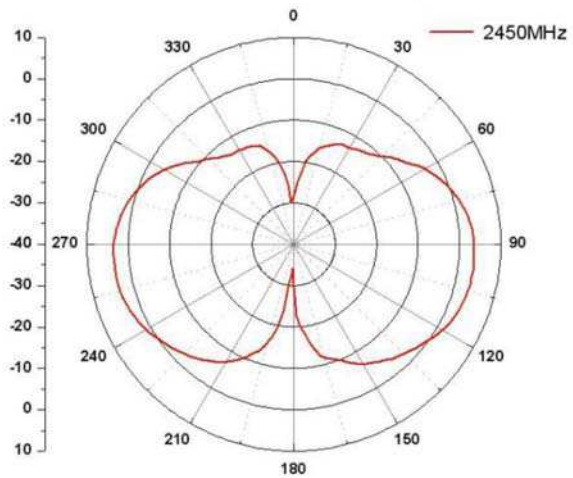
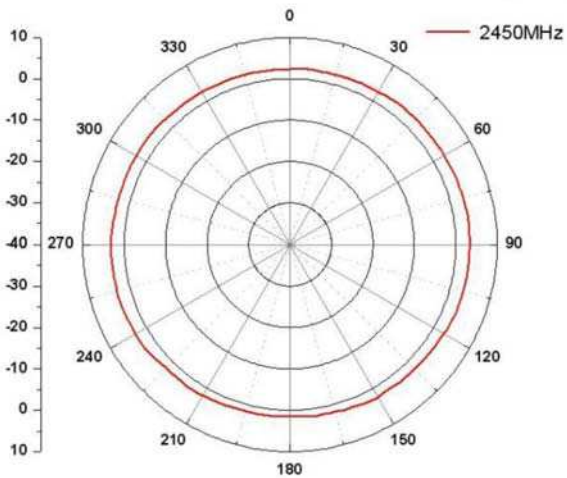

horizontal 5250 MHz

vertical 5250 MHz

Electroustic Ltd

www.electroustic.co.uk

+44 (0)1908 307200

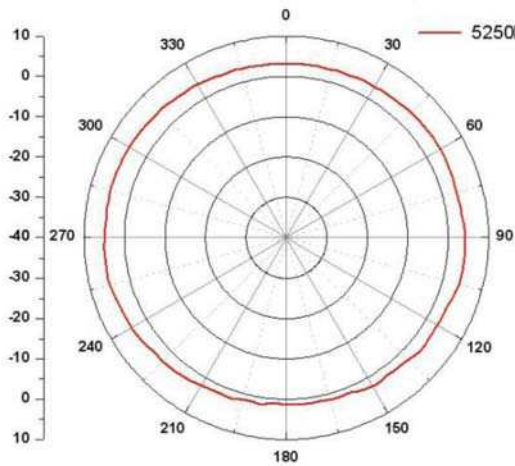

horizontal 5750 MHz

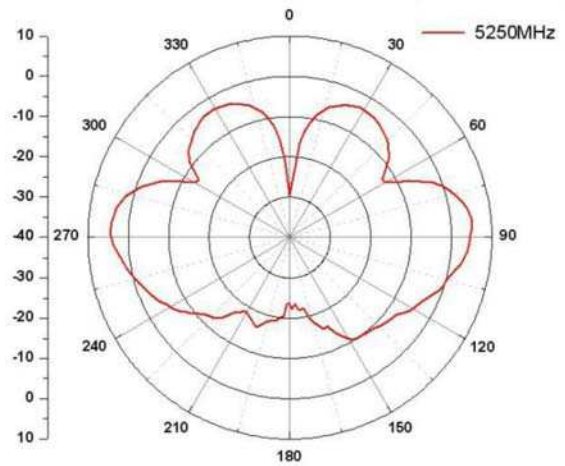

vertical 5750 MHz

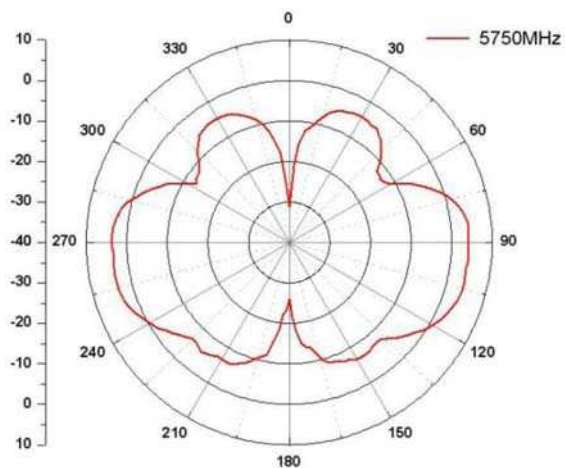
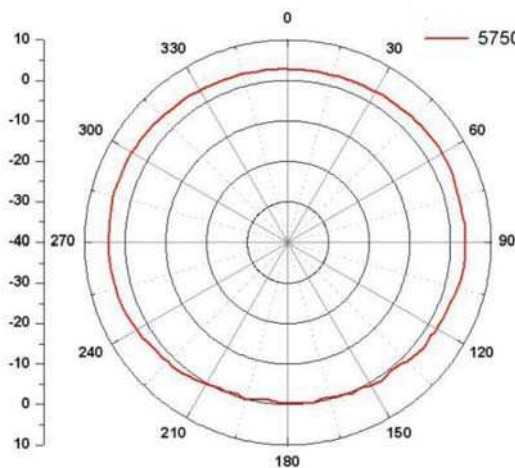

Frequency range	2400 MHz	5250 MHz and 5750 MHz
Gain	3 dBi	5 dBi
VSWR (voltage standing wave ratio)	2.0	
Polarization	Linear, vertical	
HPBW (half power bandwidth)	horizontal 360°	
HPBW (half power bandwidth)	vertical 30°	vertical 15°
Impedance	50 Ω	
Connector	Reverse-SMA male	

Table 15: Electrical Specification

Temperature	-4 °F ... +149 °F (-20 °C ... +65 °C)
Radome color	Black
Radome material	PC/PU
Weight	0.92 oz (26 g)
Dimensions	0.83 in × 6.3 in (21 mm × 160 mm)

Table 16: Environmental & Mechanical Characteristics

4.2.4 Omni-directional dual-band antennae for MiMo for the 2.4 GHz and 5 GHz bands

■ BAT-ANT-N-MiMoDB-5N-IP65

Order Number: 943 981-012



Radiation Pattern

Horizontal 2,400 MHz

Vertical 2,400 MHz

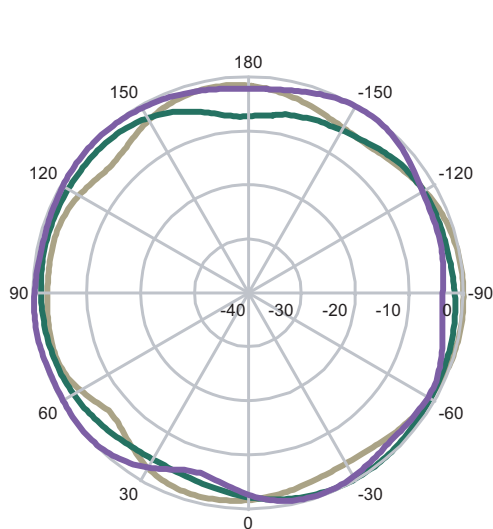

port 1
port 2
port 3

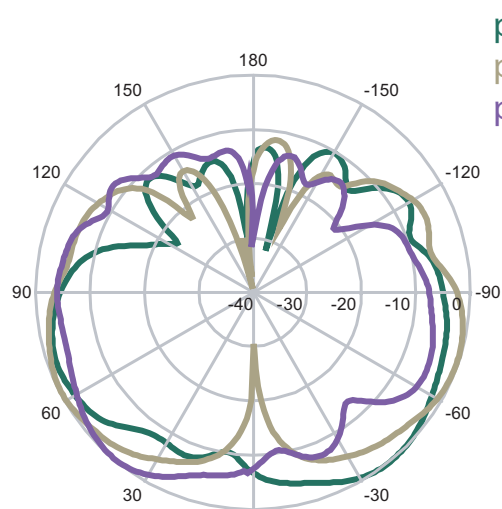

port 1
port 2
port 3

horizontal 5470 MHz

vertical 5470 MHz

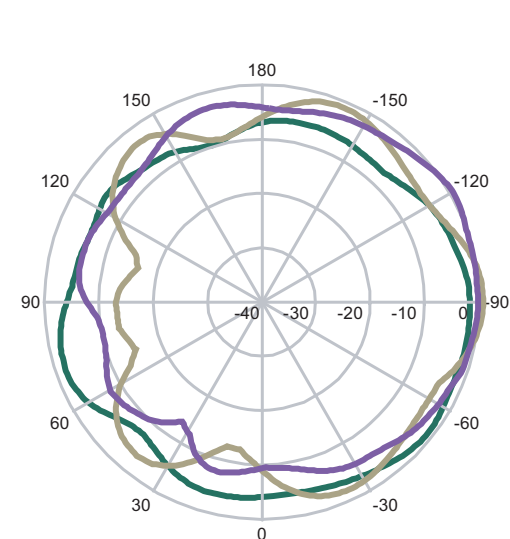

port 1
port 2
port 3

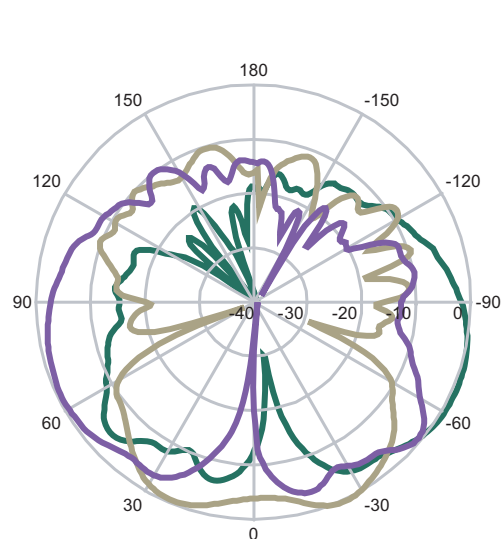

port 1
port 2
port 3

Electrooustic Ltd

www.electrooustic.co.uk

+44 (0)1908 307200

Frequency range	2400 MHz ... 2500 MHz 5150 MHz ... 5875 MHz
Gain	3.5 dBi / 5.5 dBi
VSWR (voltage standing wave ratio)	1.8
Polarization	3 × Linear, vertical
HPBW (half power bandwidth)	horizontal 360°
Downtilt	0°
Max. Power	2 W
Impedance	50 Ω
Connector	3 × N male at 3.28 ft (1 m) cable directly attached

Table 17: Electrical Specification

Temperature	-40 °F ... 176 °F (-40 °C ... +80 °C)
Radome color	7035 (Light Gray)
Radome material	plastic
Weight	0.66 lb (0.3 kg)
Dimensions	12.2 in × 4.33 in × 1.57 in (310 mm × 110 mm × 40 mm)
Protection class	IP65

Table 18: Environmental & Mechanical Characteristics

3 × 3 ft (90 cm) directly mounted to the antenna with N male connectors
3 × Pigtail, R-SMA male to N female
Mounting material

Table 19: Cable and Accessories

4.2.5 Dual band Hemispherical Antenna for 2.4 and 5 GHz band

- **BAT-ANT-N-6ABG-IP65**
Order Number: 943 981-004



Radiation Pattern	
Horizontal 2,400 MHz	Vertical 2,400 MHz
Electrostatic Ltd	+44 (0)1908 307200

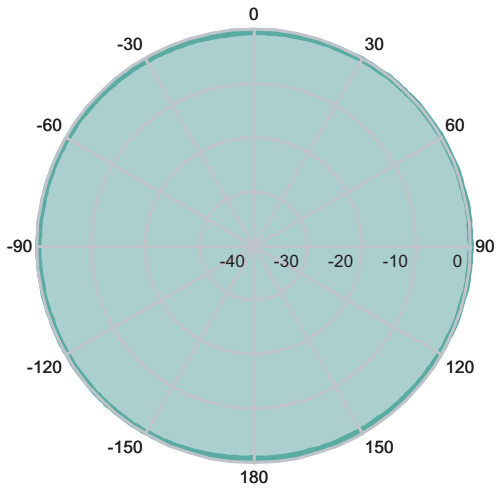

horizontal 5470 MHz

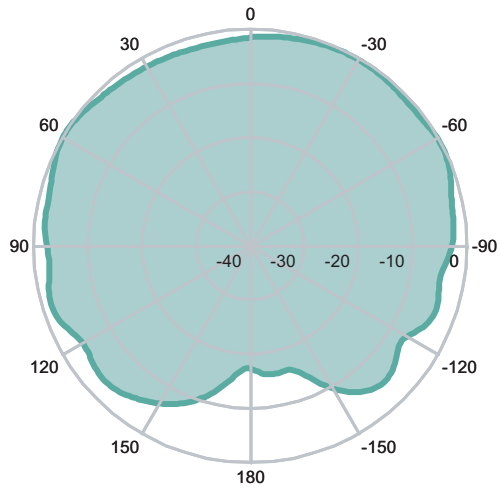

vertical 5470 MHz

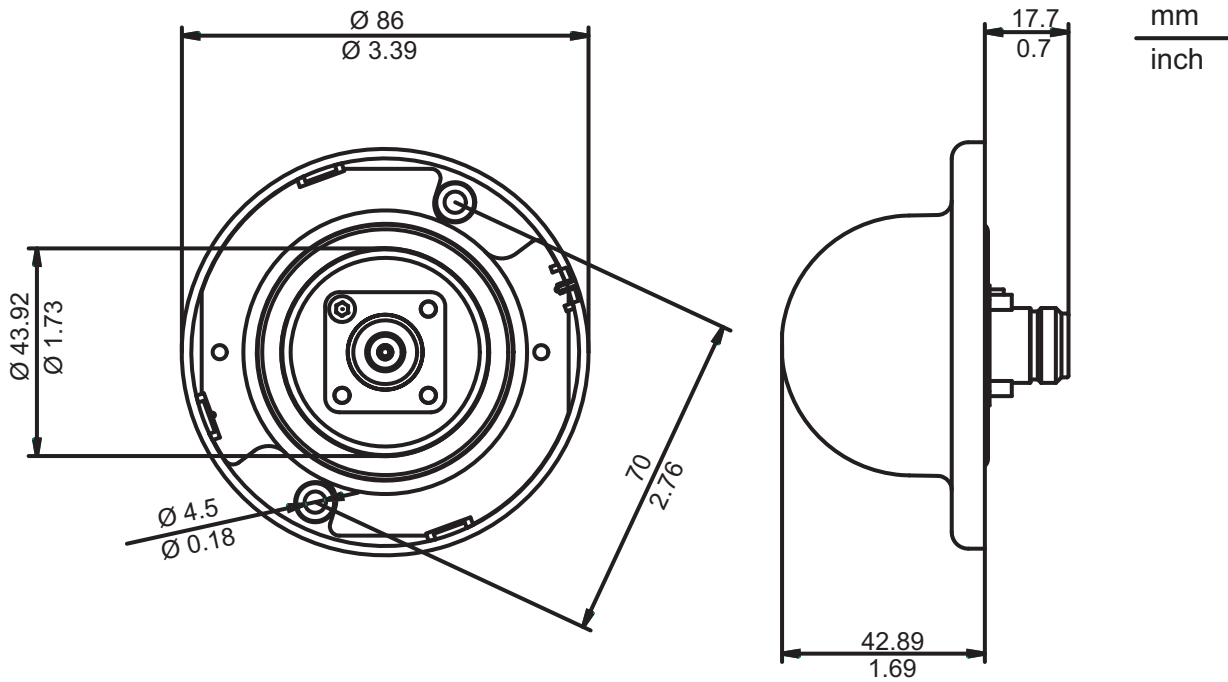
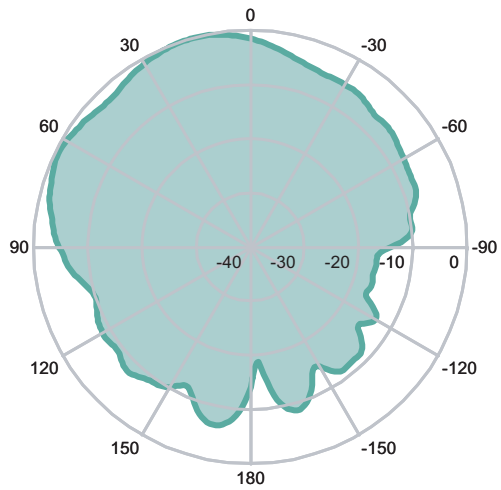
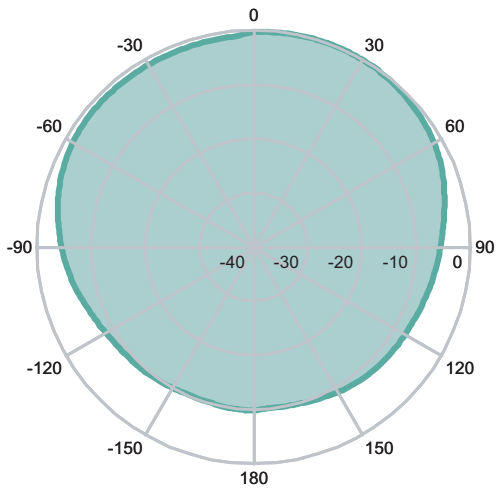

Frequency range	2300 MHz ... 2500 MHz
	4900 MHz ... 5935 MHz
Impedance	50 Ω
VSWR (voltage standing wave ratio)	1.8
Polarization	Linear, vertical
Gain	6 dBi at 2.4 GHz
	8 dBi at 5 GHz
3 dB beamwidth horizontal	at 2.4 GHz 360°
3 dB beamwidth horizontal	at 5 GHz 173°
Max. Power	75 W (CW) at 77 °F (25 °C)

Table 20: Electrical Specification

3.28 ft (1 m) with N male connectors at both ends.

Pigtail, R-SMA male to N female

Table 21: Cable and Accessories

4.3 Sector Antennas

4.3.1 Directional antenna for the 2.4 GHz band with 8 dBi gain

■ **BAT-ANT-N-8G-DS-IP65**

Order Number: 943 981-009



Radiation Pattern

Horizontal 2,400 MHz

Vertical 2,400 MHz

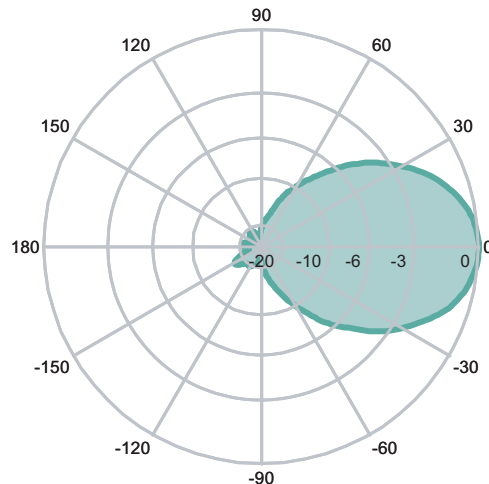
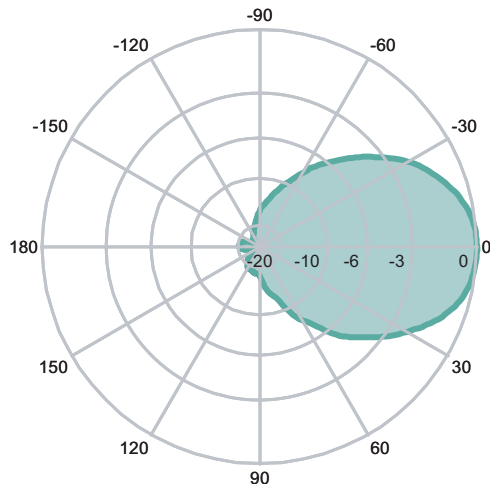

Table 22: Directional characteristic

Frequency range	2400 MHz ... 2485 MHz
Impedance	50 Ω
VSWR (voltage standing wave ratio)	1.5
Polarization	dual linear, $\pm 45^\circ$ slant
Gain	8 dBi
3 dB beamwidth horizontal	75°
3 dB beamwidth vertical	70°
Downtilt	0°
Isolation between ports	25 dB
Front to back ratio	14 dB

Table 23: Electrical Specification

Electroustic Ltd

www.electroustic.co.uk

+44 (0)1908 307200

Max. Power	10 W (CW) at 77 °F (25 °C)
Connector	2 × N female

Table 23: Electrical Specification

Dimensions	3.98 in × 3.15 in × 1.38 in (101 mm × 80 mm × 35 mm)
Weight	0.24 lb (0.11 kg)
Radome material	LEXAN EXL 9330
Radome color	RAL 7044 (silk gray)
Operating temperature range	-40 °F ... 176 °F (-40 °C ... +80 °C)
Storage temperature range	-40 °F ... 176 °F (-40 °C ... +80 °C)
Windload	3.37 lbf at 99 m/h (15 N at 160 km/h)
Protection class	IP65

Table 24: Mechanical Properties

2 × 3.28 ft (1 m) with N male connectors at both ends
2 × Pigtail, R-SMA male to N female
Mounting material

Table 25: Cable and Accessories

4.3.2 Polarization-diversity antenna for 5 GHz band, linear

■ BAT-ANT-N-9A-DS-IP65

Order Number: 943 981-010



Radiation Pattern

horizontal 5470 MHz

vertical 5470 MHz

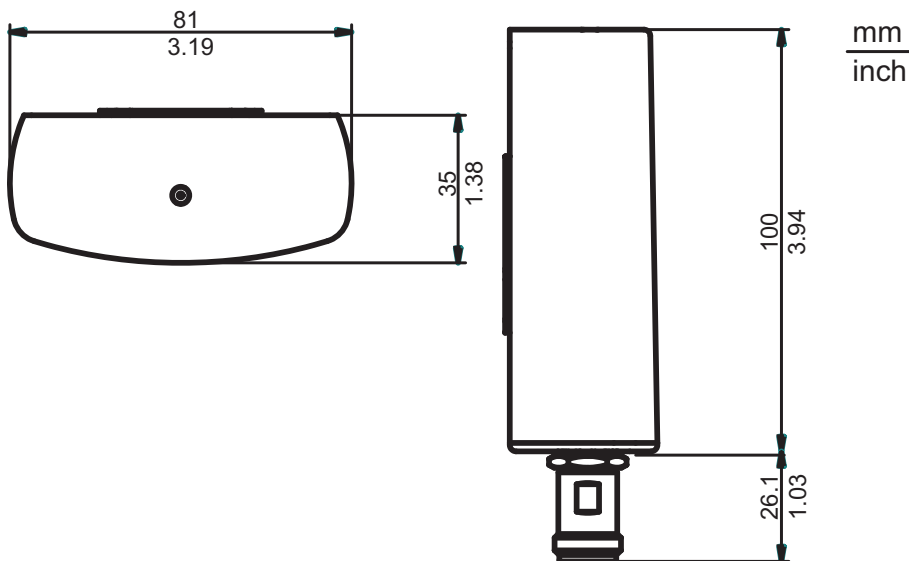
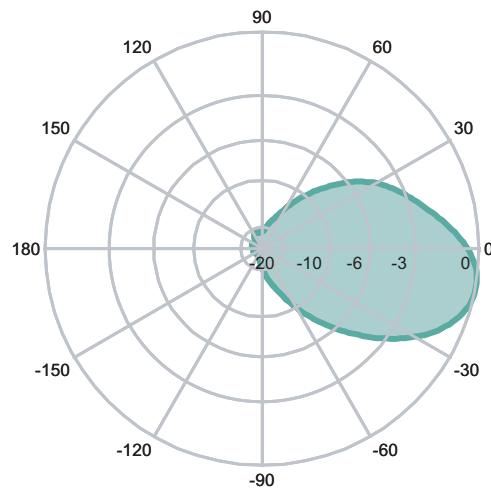
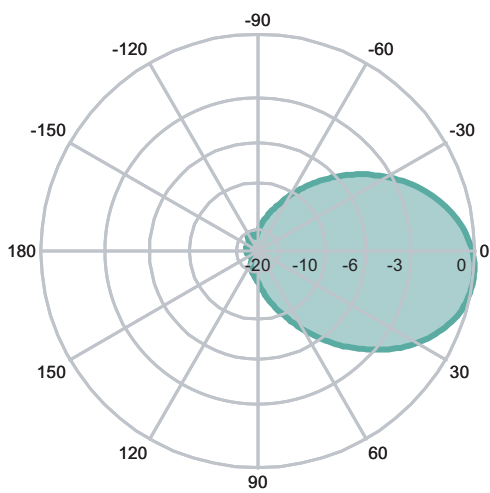

Frequency range	5150 MHz ... 5925 MHz
-----------------	-----------------------

Impedance	50 Ω
-----------	-------------

Table 26: Electrical Specification

+44 (0)1908 307200

VSWR (voltage standing wave ratio)	2
Polarization	dual linear, $\pm 45^\circ$ slant
Gain	9 dBi
3 dB beamwidth horizontal	70°
3 dB beamwidth vertical	60°
Downtilt	0°
Isolation between ports	20 dB
Front to back ratio	20 dB
Max. Power	10 W (CW) at 77°F (25°C)
Connector	2 \times N female

Table 26: Electrical Specification

Dimensions	3.98 in \times 3.15 in \times 1.38 in (101 mm \times 80 mm \times 35 mm)
Weight	0.24 lb (0.11 kg)
Housing material	ASA and aluminum
Radome material	ASA
Radome material	LEXAN EXL 9330
Radome color	RAL 7044 (silk gray)
Operating temperature range	-40°F ... 176°F (-40°C ... $+80^\circ\text{C}$)
Storage temperature range	-40°F ... 176°F (-40°C ... $+80^\circ\text{C}$)
Windload	3.37 lbf at 99 m/h (15 N at 160 km/h)
Protection class	IP65

Table 27: Mechanical Properties

2 \times 3.28 ft (1 m) with N male connectors at both ends
2 \times Pigtail, R-SMA male to N female
Mounting material

Table 28: Cable and Accessories

4.3.3 Sectoral MiMoantenna for 5 GHz band

■ **BAT-ANT-N-MiMo5-9N-IP65**

Order Number: 943 981-013



Radiation Pattern

horizontal – connection 1

vertical – connection 1

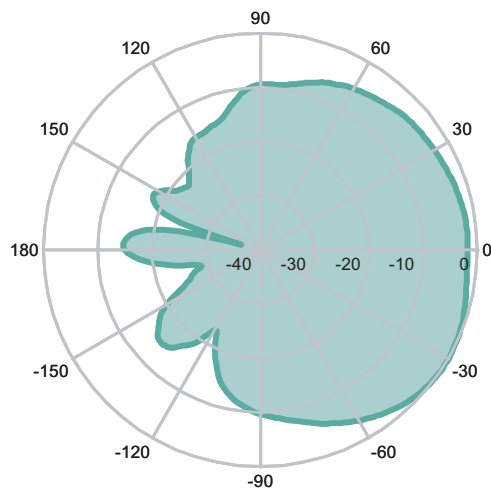
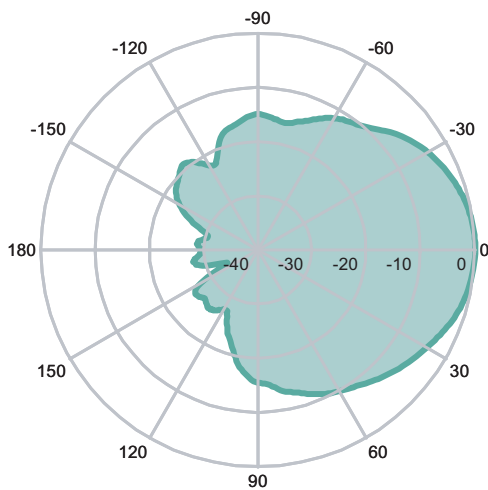

horizontal – connection 2

vertical – connection 2

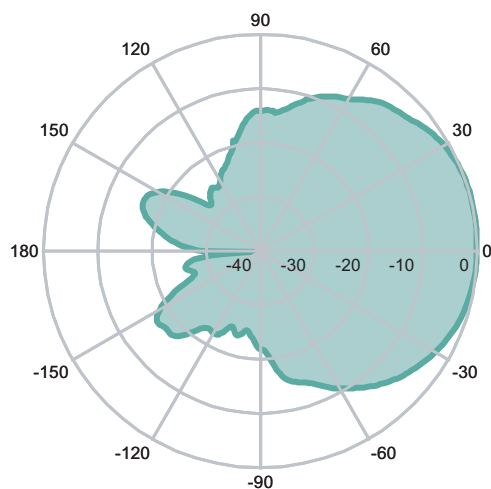
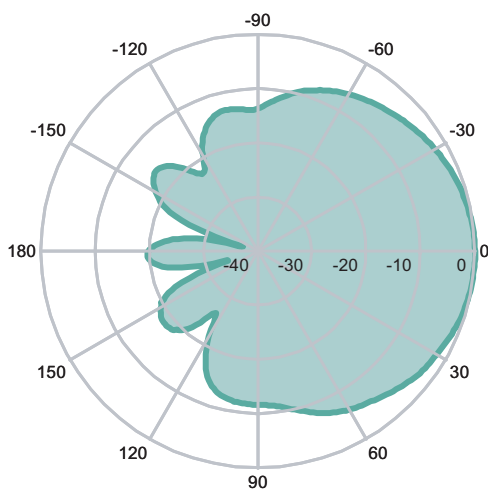

horizontal – connection 3

vertical – connection 3

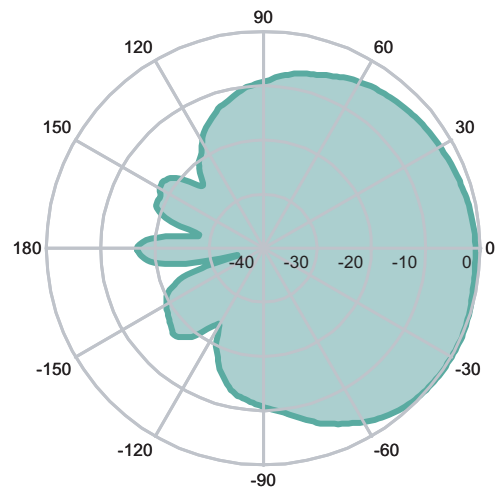
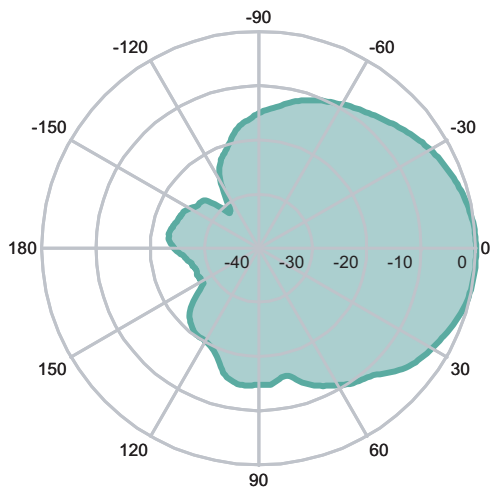

Frequency range	5150 MHz ... 5875 MHz
Impedance	50 Ω
VSWR (voltage standing wave ratio)	1.5
Polarization	3 × linear vertical / horizontal / +45°
Gain	9 dBi
3 dB beamwidth horizontal	65°
3 dB beamwidth vertical	65°
Downtilt	0°
Max. Power	2 W (CW) at 77 °F (25 °C)
Connector	N female

Table 29: Electrical Specification

Dimensions	3.98 in × 3.15 in × 1.38 in (101 mm × 80 mm × 35 mm)
Weight	0.24 lb (0.11 kg)
Radome material	LEXAN EXL 9330
Radome color	RAL 7044 (silk gray)
Operating temperature range	-40 °F ... 176 °F (-40 °C ... +80 °C)
Storage temperature range	-40 °F ... 176 °F (-40 °C ... +80 °C)
Windload	3.37 lbf at 99 m/h (15 N at 160 km/h)
Protection class	IP65

Table 30: Mechanical Properties

3 × 3.28 ft (1 m) with N male connectors at both ends
3 × Pigtail, R-SMA male to N female
Mounting material

Table 31: Cable and Accessories

4.4 Directional Antennas

4.4.1 Directional antenna for the 2.4 GHz band with 14 dBi gain

■ **BAT-ANT-N-14G-IP23**

Order Number: 943 981-005



Radiation Pattern

Horizontal 2,400 MHz

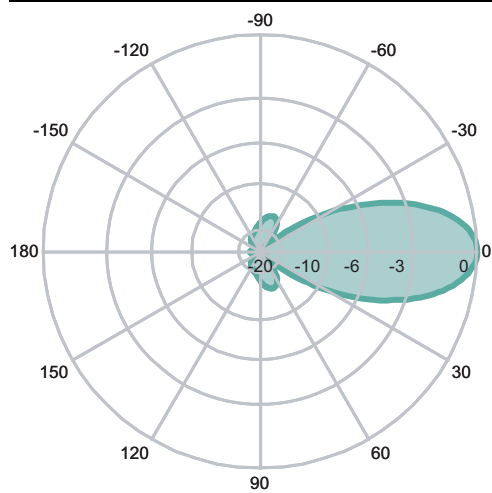

Vertical 2,400 MHz

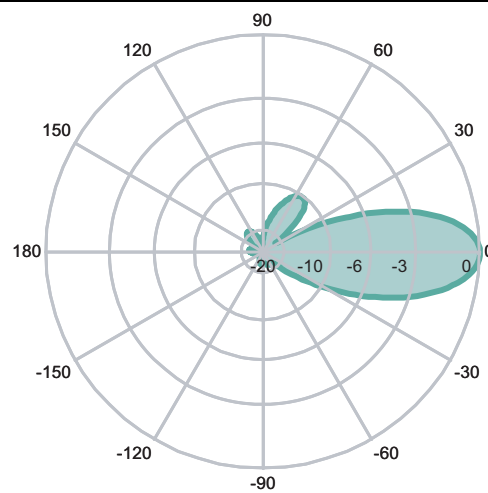

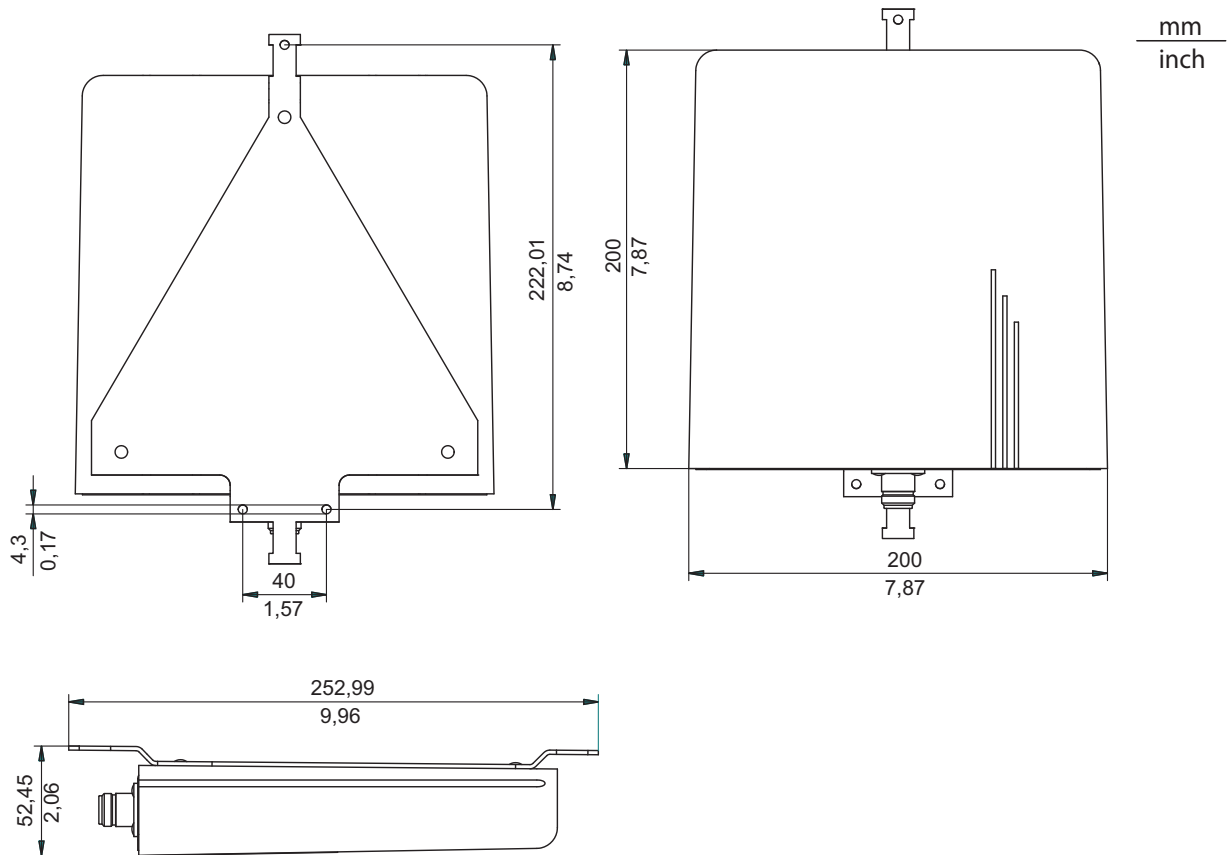

Frequency range	2300 MHz ... 2500 MHz
Impedance	50 Ω
VSWR (voltage standing wave ratio)	1.5
Polarization	vertical
Gain	14 dBi
3 dB beamwidth horizontal	35°
3 dB beamwidth vertical	30°
Downtilt	0°
Front to back ratio	20 dB
Max. Power	75 W (CW) at 77 °F (25 °C)
Connector	N female

Table 32: Electrical Specification

Dimensions	3.98 in × 3.15 in × 1.38 in (101 mm × 80 mm × 35 mm)
Weight	0.24 lb (0.11 kg)
Radome material	LEXAN EXL 9330
Radome color	RAL 7044 (silk gray)
Operating temperature range	-40 °F ... 176 °F (-40 °C ... +80 °C)
Storage temperature range	-40 °F ... 176 °F (-40 °C ... +80 °C)
Windload	3.37 lbf at 99 m/h (15 N at 160 km/h)
Protection class	IP23

Table 33: Mechanical Properties

3.28 ft (1 m) with N male connectors at both ends.

Pigtail, R-SMA male to N female

Mounting material

Table 34: Cable and Accessories

Note: Applies for use in the EU: If you use the antenna BAT-ANT-N-14G-IP23 in combination with OpenBAT family devices, use the supplied 1 m (3.28ft) antenna cable in combination with BAT-CLB-2 N m-f cable.

4.4.2 Directional antenna for 5 GHz band with 18 dBi gain

■ BAT-ANT-N-18A-V-IP65

Order Number: 943 981-006



Due to their compact design, several of these antennas can be mounted on a single post. For better separation of the spatial streams with MiMo, you mount the antennas with different alignments (polarizations).

Example:

1st antenna: vertical

2nd antenna: horizontal

3rd antenna: 45° horizontal

Radiation Pattern

horizontal 5470 MHz

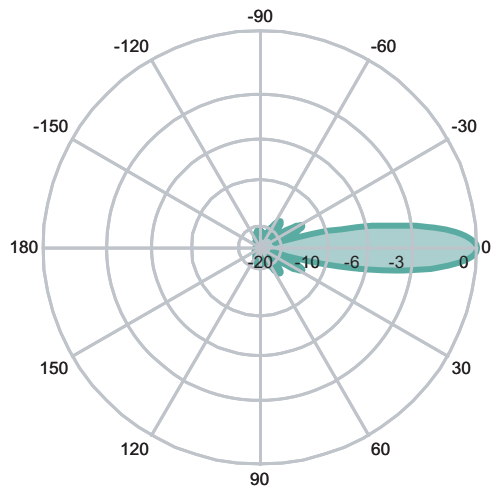

vertical 5470 MHz

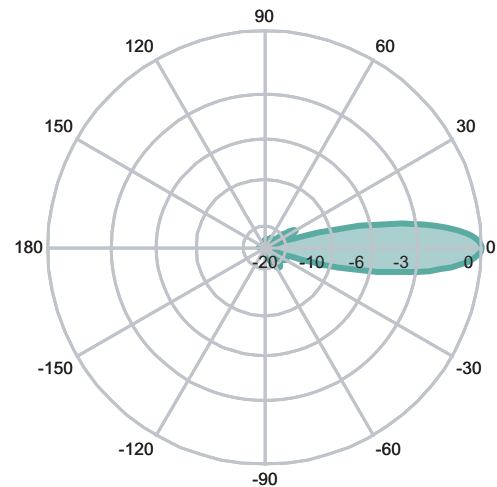

Frequency range

5150 MHz ... 5250 MHz

5250 MHz ... 5350 MHz

5350 MHz ... 5725 MHz

5725 MHz ... 5875 MHz

Gain

18 dBi

19 dBi

18.5 dBi

18 dBi

Table 35: Electrical Specification

Electrooustic Ltd www.electrooustic.co.uk

+44 (0)1908 307200

Polarization	Linear, vertical
HPBW / horizontal	18°
HPBW / vertical	18°
Front to back ratio	> 30 dB
Power handling	6 W (CW)
Impedance	50 Ω
Connector	N Jack

Table 35: Electrical Specification

Windload @ wind speed	23.4 lbf at 64 m/h (104 N at 216 km/h)
Temperature	-49 °F ... +158 °F (-45 °C ... +70 °C)
Radome material	plastic
Radome color	7035 (Light Gray)
Weight	0.11 kg, 0.24 lb
Dimensions	7.48 in × 7.48 in × 1.2 in (190 mm × 190 mm × 30.5 mm)
Protection class	IP65 / IP67

Table 36: Environmental & Mechanical Characteristics

3.28 ft (1 m) with N male connectors at both ends.
Pigtail, R-SMA male to N female
Mounting material

Table 37: Cable and Accessories

■ **BAT-ANT-N-23A-V-IP65**

Order Number: 943 981-007



Relevant for North America:

Operate the antennas BAT-ANT-N-23A-V-IP65 and BAT-ANT-N-23A-VH-IP65 exclusively in point-to-point connections.

Due to their compact design, several of these antennas can be mounted on a single post. For better separation of the spatial streams with MiMo, you mount the antennas with different alignments (polarizations).

Example:

[Electroustic Ltd](http://www.electroustic.com)

www.electroustic.co.uk

+44 (0)1908 307200

1st antenna: vertical
 2nd antenna: horizontal
 3rd antenna: 45° horizontal

Radiation Pattern

horizontal 5470 MHz

vertical 5470 MHz

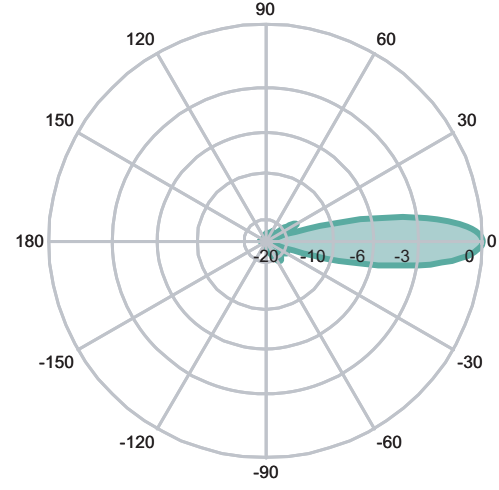
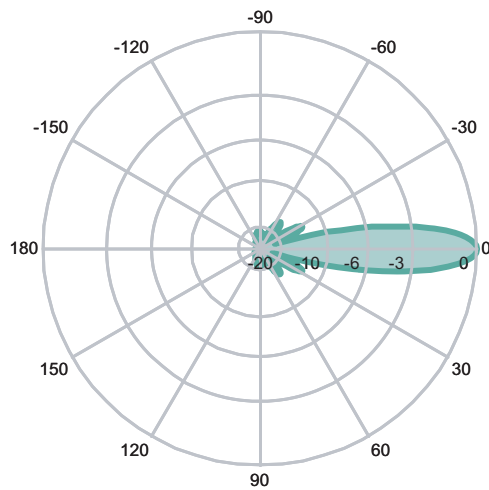

Frequency range	5150 MHz ... 5350 MHz 5470 MHz ... 5875 MHz
Gain	23 dBi
VSWR (voltage standing wave ratio)	< 1.5
Polarization	Linear, vertical
HPBW / horizontal	9°
HPBW / vertical	9°
Front to back ratio	> 30 dB
Max. Power	6 W
Impedance	50 Ω
Connector	N Jack

Table 38: Electrical Specification

Windload @ wind speed	59.3 lbf at 136 m/h (264N at 220 km/h)
Temperature	-49 °F ... +158 °F (-45 °C ... +70 °C)
Radome material	plastic
Radome color	Grey-white
Weight	3.31 lb (1.5 kg)
Dimensions	12.01 in × 12.01 in × 0.98 in (305 mm × 305 mm × 25 mm)
Protection class	IP65 / IP67

Table 39: Environmental & Mechanical Characteristics

3.28 ft (1 m) with N male connectors at both ends.

Pigtail, R-SMA male to N female

Mounting material for wall and mast mount

Table 40: Cable and Accessories

4.4.3 Directional antenna for 5 GHz band with a gain of 23 dBi

■ BAT-ANT-N-23A-VH-IP65

Order Number: 943 981-008

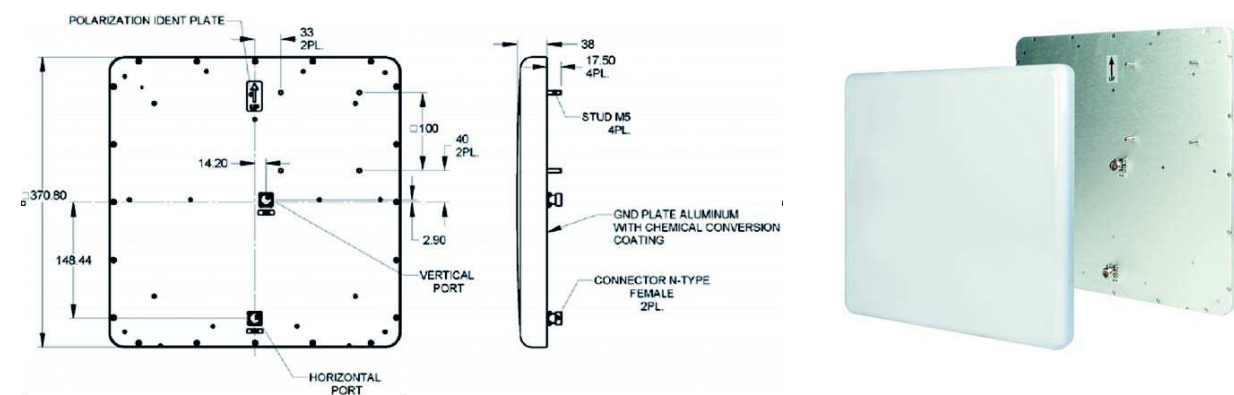

Radiation Pattern

Connection: horizontal / polarization: horizontal Connection: horizontal / polarization: vertical (5,470 MHz)

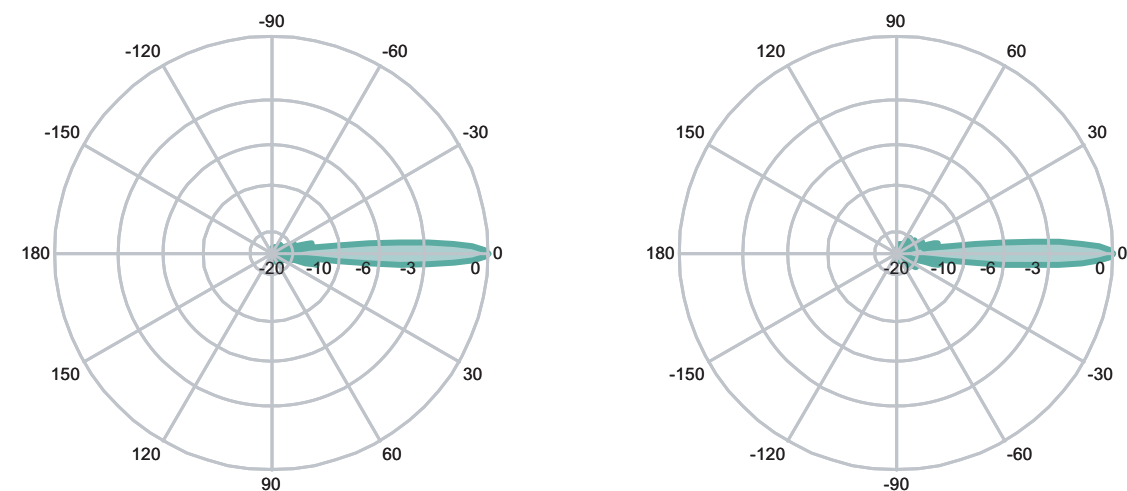

Connection: vertical / polarization: horizontal
(5,470 MHz)

Connection: vertical / polarization: vertical
(5,470 MHz)

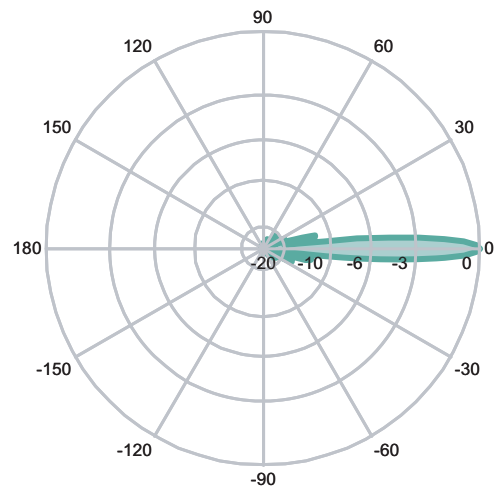
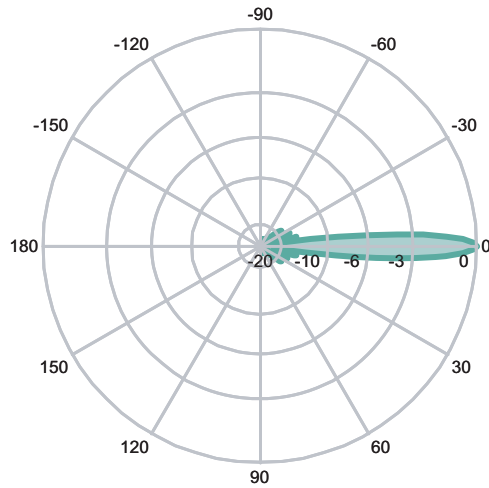

Frequency range	5150 MHz ... 5875 MHz
Gain	23 dBi
VSWR (voltage standing wave ratio)	< 1.7
Polarization	dual Linear, vertical and horizontal
HPBW / horizontal	9°
HPBW / vertical	9°
Front to back ratio	-30 dB
Max. Power	6 W
Impedance	50 Ω
Connector	2 × N female

Table 41: Electrical Specification

Windload @ survival speed	59.3 lbf at 136 m/h (264N at 220 km/h)
Temperature	-49 °F ... +158 °F (-45 °C ... +70 °C)
Radome material	plastic
Radome color	Grey-white
Weight	5.51 lb (2.5 kg)
Dimensions	14.61 in. × 14.61 in. × 1.57 in. (371 mm × 371 mm × 40 mm)
Protection class	IP65 / IP67

Table 42: Environmental & Mechanical Characteristics

2 × 3.28 ft (1 m) with N male connectors at both ends

2 × Pigtail, R-SMA male to N female

Mounting material for wall and mast mount

Table 43: Cable and Accessories

4.4.4 Directional antenna for 5 GHz band with 18 dBi gain

■ **BAT-ANT-N-MiMo-18N-IP65**

Order Number: 943 981-014

MiMo is achieved via polarization diversity.



Relevant for North America:

See “Legal regulations for operation external antennas” on page 14.

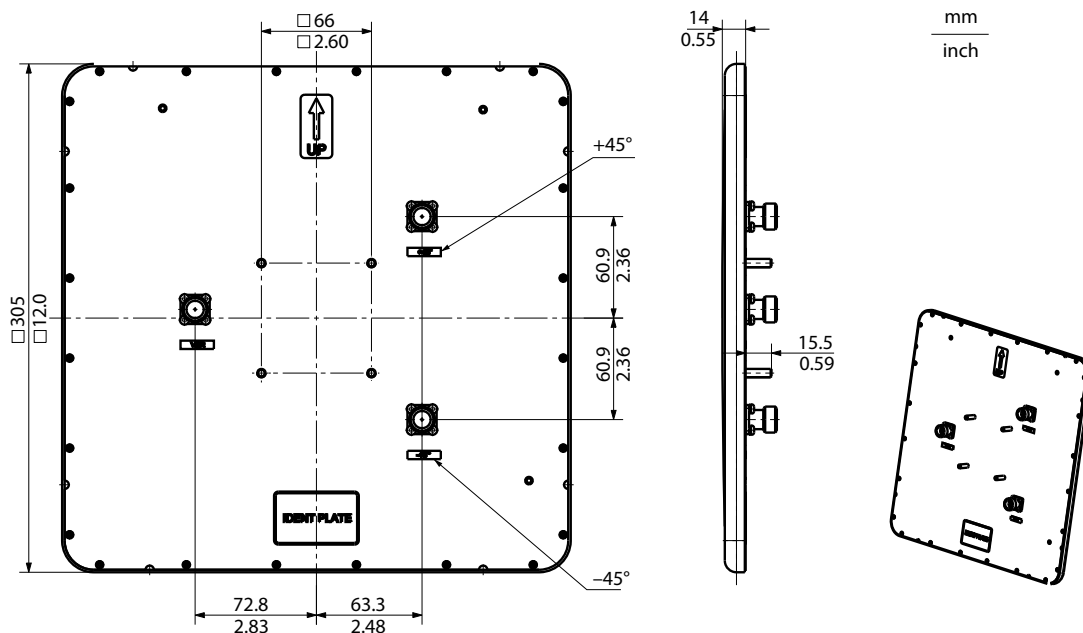

Radiation Pattern

5 GHz

horizontal - connection on the right (+45°)

vertical - connection on the right (+45°)

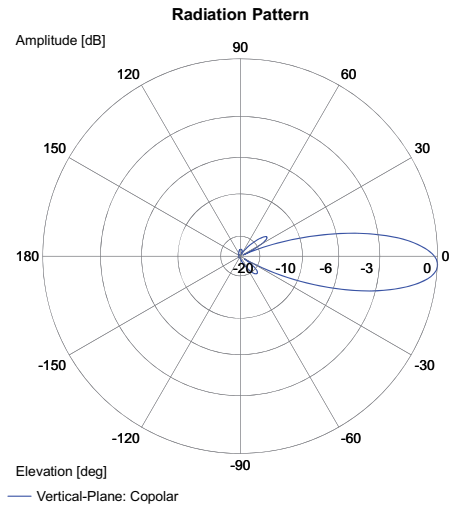
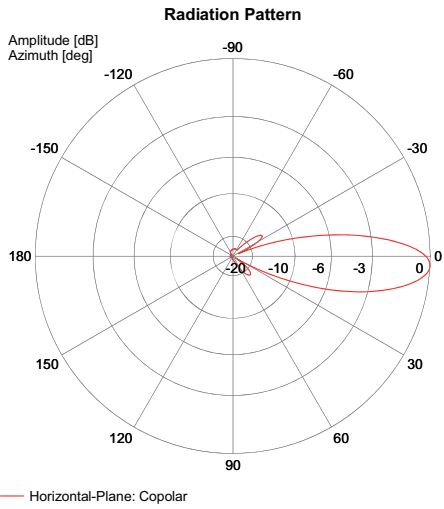

horizontal - connection on the left (-45°)

vertical - connection on the left (-45°)

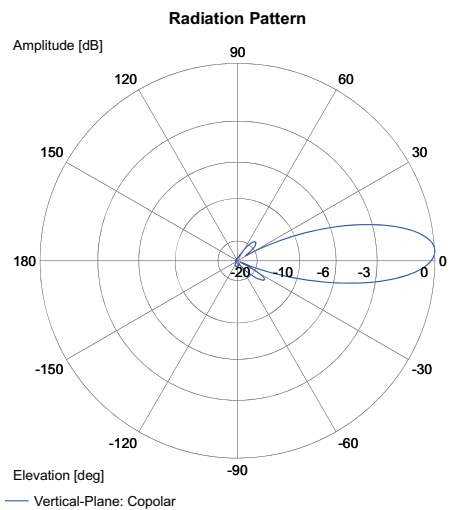
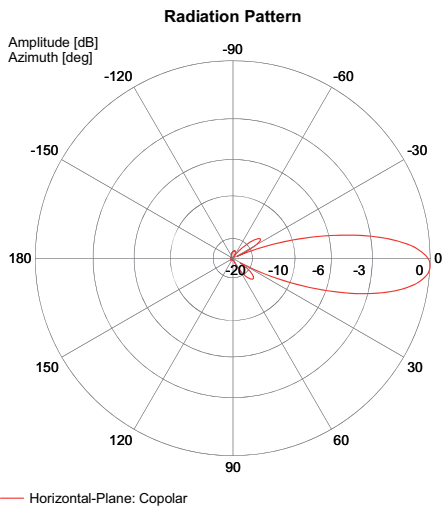

horizontal - vertical connection

vertical - vertical connection

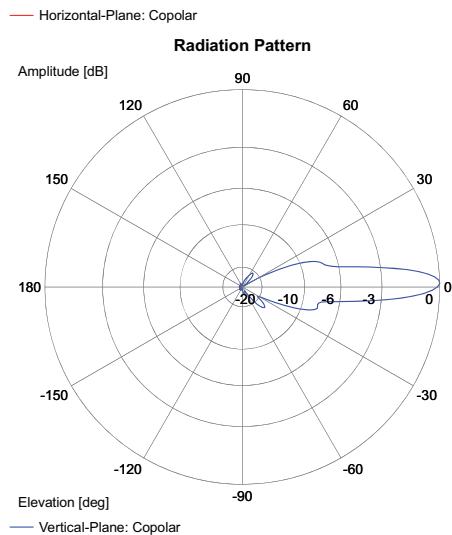
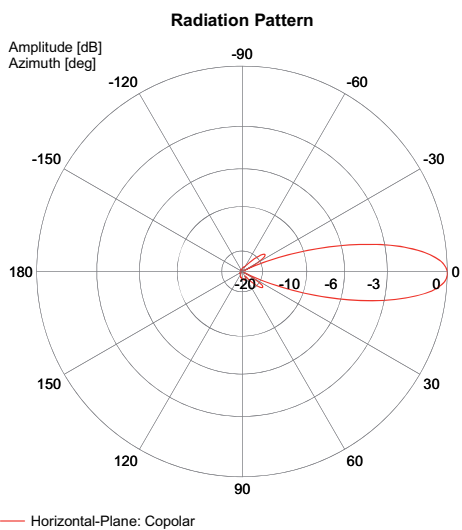

	Band 1	Band 2	Band 3
Frequency range	4900 MHz ... 5150 MHz	5150 MHz ... 6000 MHz	6000 MHz ... 6100 MHz
VSWR (voltage standing wave ratio)	1.8	1.8	1.8
Gain	17 dBi	18 dBi	16 dBi
HPBW / vertical	20°		15°

Table 44: Electrical Specification

Polarization	0°, +/-45° inclination
Max. Power	6 W
Impedance	50 Ω
Connector	N Jack

Table 45: General data

Windload @ survival speed	263 N at 136 m/h (263 N at 220 km/h)
Temperature	-49 °F ... +158 °F (-45 °C ... +70 °C)
Radome material	plastic
Radome color	Grey-white
Weight	3.31 lb (1.5 kg)
Dimensions	12.01 in × 12.01 in × 0.59 in (305 mm × 305 mm × 15 mm)
Protection class	IP67

Table 46: Environmental & Mechanical Characteristics

3 × 3.28 ft (1 m) with N male connectors at both ends
3 × Pigtail, R-SMA male to N female
Mounting material for wall and mast mount

Table 47: Cable and Accessories

4.5 Radiating Cable Antennas (Leaky Cable)

4.5.1 Leaky Cable for 2.4 GHz; black

Radiating cables are coaxial cables that are equipped with small slots in their shields at regular intervals that operate as antennas. This leads to a homogeneous field around the cable.



The 100 m (328 ft) cable is designed to be fed by 2 access points, each feeding the cable for approximately 50 m (164 ft). The 50 m (164 ft) cable is designed to be used with one Access Point and equipped with a terminator at the end.

■ **BAT-ANT-N-LC-G-50m-IP65**

Order Number: 943 981-001



Cable length	164 ft (50 m)
Cable specification	2 × N male connectors; 0.15 dB at 2.4 GHz

Table 48: Specification

Frequency band	2000 MHz - 2900 MHz
Antenna connector	N-type male

Table 49: Radio technology

Operating temperature	-40 °F ... +185 °F (-40 °C ... +85 °C)
Storage/transport temperature	-70 °C ... +85 °C
Dimensions	164 ft (50 m); d = 0.6 in (15 mm)
Protection class	IP65
Weight	26.5 lb (12 kg)

Table 50: Ambient conditions

Halogen free and flame retardant outer sheath
Low corrosive gas emission according to IEC 60754-2
Flame retardant according to IEC 60332-1 and IEC 60332-3 cat. C
Low smoke emission according to IEC 61034

Table 51: Flammability Characteristics

Leaky Cable
2 × N-connector, preassembled
1 × terminating resistor 50 Ohm
50 × fastening clip

Table 52: Scope of delivery and accessories

■ **BAT-ANT-N-LC-G-100m-IP65**

Order Number: 943 981-101



Cable length	100 m, 328 ft
Cable specification	2 × N male connectors; 0.15 dB at 2.4 GHz

Table 53: Specification

Frequency band	2000 MHz - 2900 MHz
Antenna connector	N-type male

Table 54: Radio technology

Operating temperature	-40 °F ... +185 °F (-40 °C ... +85 °C)
Storage/transport temperature	-70 °C ... +85 °C
Dimensions	328 ft (100 m); d = 0.6 in (15 mm)
Protection class	IP65
Weight	53 lb (24 kg)

Table 55: Ambient conditions

Halogen free and flame retardant outer sheath
Low corrosive gas emission according to IEC 60754-2
Flame retardant according to IEC 60332-1 and IEC 60332-3 cat. C
Low smoke emission according to IEC 61034

Table 56: Flammability Characteristics

Leaky Cable
2 × N-connector, preassembled
1 × terminating resistor 50 Ohm
100 × fastening clip

Table 57: Scope of delivery and accessories

Configurations Longitudinal Attenuation

	db/328 ft (dB/100 m)
LC at 4 in (10 cm) from a concrete floor	15
LC at 0.6 in (15 mm) from a metal surface	17
LC directly against a metal surface	34

Table 58: Longitudinal attenuation of both cables between 2.4 and 2.485 GHz

Electroustic Ltd

www.electroustic.co.uk

+44 (0)1908 307200

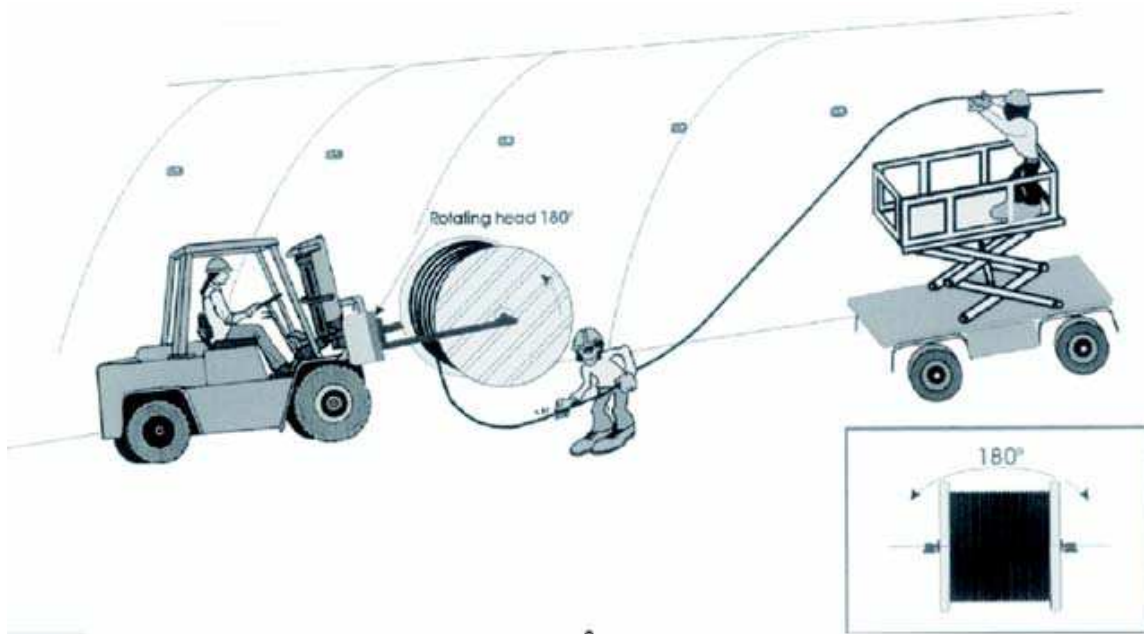

Figure 1: Mounting a leaky wave conductor in the tunnel. Fastening clips are included in the delivery.

5 Cables/Adapter

All antennas are supplied with 1 m cable / N-plug to N-jack and pigtail.

■ **BAT-CLB-2 N m-f, BAT-CLB-2 N f-f**

Order Number:	m-m: 943 903-513
	m-f: 943 903-514



Length	6.56 ft (2 m)
Diameter	6 mm
Attenuation	1.4 dB / 2.4 GHz 3 dB / 5 GHz
Connector	N male to female
Protection class	IP65

Table 59: Characteristics

Temperature range	-40 °F ... +185 °F (-40 °C ... +85 °C)
Installation temperature range	-20 °C ... +60 °C
Flammability	UL 1581 § 1080 (VW-1)
Halogen-free	in compliance with IEC 60754
2002/95/EC (RoHS) compliant	

Table 60: Flammability Characteristics

■ **BAT-CLB-5 N m-f**

Order Number: 943 903-516



Length	16.4 ft (5 m)
Diameter	13 mm
Attenuation	1.3 dB / 2.4 GHz 2.3 dB / 5 GHz
Connector	N male/ N female

Table 61: Characteristics

Temperature range	-40 °F ... +185 °F (-40 °C ... +85 °C)
Installation temperature range	-20 °C ... +60 °C
Flammability	UL 1581 § 1080 (VW-1)
Halogen-free	in compliance with IEC 60754
2002/95/EC (RoHS) compliant	

Table 62: Flammability Characteristics

■ **BAT-CLB-15 N m-f**

Order Number: 943 903-515



Length	49,2 ft (15 m)
Diameter	13 mm
Attenuation	3 dB / 2.4 GHz 4 dB / 5 GHz
Connector	N male/ N female

Table 63: Characteristics

Temperature range	-40 °F ... +185 °F (-40 °C ... +85 °C)
Installation temperature range	-20 °C ... +60 °C
Flammability	UL 1581 § 1080 (VW-1)
Halogen-free	in compliance with IEC 60754
2002/95/EC (RoHS) compliant	

Table 64: Flammability Characteristics

■ **BAT-Pigtail**

Order Number: 943 903-360



Length	0.66 ft (0.2 m)
Diameter	6 mm
Attenuation	0.5 dB / 2.4 GHz 1 dB / 5 GHz
Connector	N female/ RPSMA-Plug

Table 65: Characteristics

■ BAT-ANT-Protector m-f

Order Number: 943 903-373



The BAT-ANT-Protector m-f is a bandpass with electrical insulation. It helps prevent damage due to electrostatic discharging.

The BAT-ANT-Protector m-f can enable a watertight connection to the switch cabinet.

This device is strongly recommended to be used in- and outdoor wherever electrical discharge, overvoltage or unclear grounding occur. Please refer to the Outdoor Installation Guide for how to mount and plan the installation.

Main path connectors	Connection 1: N socket, protected (electrically isolated) Connection 2: N socket, unprotected
Mounting and grounding	MH170/brk (MH=bulkhead mounting/brk=bracket)
Side of bulkhead	protected side
Design specialty	inline design

Table 66: Product Configuration

Impedance	50 Ω
Frequency range	2000 MHz ... 6000 MHz
Return loss	≥ 20 dB
Insertion loss	≤ 0.2 dB
RF CW power	≤ 300 W
Surge current handling capability	50 multiple kA (test pulse 8/20 μ s)
Residual pulse energy	0.0001 μ J typically (test pulse 4 kV 1.2/50 μ s / 2 kA 8/20 μ s) Main path - protected side

Table 67: Electrical Specification

Weight	0.19 lb (0.085 kg)
Operating temperature	-40 °F ... +185 °F (-40 °C ... +85 °C)
Waterproof degree	IP65 (according to IEC 60529, data refers to the coupled state)
2002/95/EC (RoHS)	compliant

Table 68: Environmental & Mechanical Characteristics

■ **BAT-LAN-Protector IP68**

Order Number: 943 903-374



Overvoltage protector for the PoE/LAN cable.
Please refer to the Outdoor Installation Guide for how to mount and plan the installation.

Main path connectors	RJ45 jack (female) – RJ45 jack (unprotected side – protected side)
Mounting	via mounting bracket
Grounding	via mounting bracket or grounding M6 screw (ring of cable shoe > 0.26 in (6.5 mm))

Table 69: Product Configuration

Data transmission rate	1000 Mbit/s	
Frequency range	DC to 100 MHz	
Impedance	100 Ω	
Current rating	per pair	1.5 A max.
Response Time	2 ns	
Current handling capability	wire - wire	0.1 kA (test pulse 8/20 μs)
	wire - ground	2.5 kA (test pulse 8/20 μs)
	shield – ground	6 kA (test pulse 8/20 μs)
Protection level	wire - wire	20 V typically (test pulse 4 kV 1.2/50 μs / 2 kA 8/20 μs)
	wire - ground	700 V typically (test pulse 4 kV 1.2/50 μs / 2 kA 8/20 μs)
	shield – ground	700 V typically (test pulse 4 kV 1.2/50 μs / 2 kA 8/20 μs)
Clamping voltage	wire - wire	15 V
	wire - ground	90 V
	shield – ground	90 V

Table 70: Electrical Specification

Cable category	according to ISO/IEC 11801:2002 class D specified (up to CAT-5e system)
Operating temperature	-40 °F ... +185 °F (-40 °C ... +85 °C)
Protection class	IP68
Weight	0.73 lb (0.33 kg)

Table 71: Environmental & Mechanical Characteristics

A Explanation of passive antennas in explosive hazard areas

Hirschmann BAT antennas are passive devices which are not able to increase the power by themselves.

Devices which are specified in accordance with the ATEX directive complying with the technical standards EN 60079-0 and EN 60079-15 can be operated with all associated Hirschmann BAT antennas. You recognize the specified devices by their device label.

With the use of the prescribed device configuration, the 2 Watts maximum power permitted for the ATEX equipment group IIC is not reached in the following bands:

- ▶ 2.4 GHz ... 2.4835 GHz
- ▶ 5.15 GHz ... 5.35 GHz
- ▶ 5.47 GHz ... 5.725 GHz

B Antenna diagrams

This chapter was produced with the generous support of Huber+Suhner GmbH.

■ Polarization and transmission

The following section explains the vertical and horizontal polarization:

► Vertical polarization

With vertical polarization, the electrical field runs perpendicular to the earth's surface. The magnetic field runs perpendicular to the electrical field in transmission direction 'z' - that is, parallel to the earth's surface.

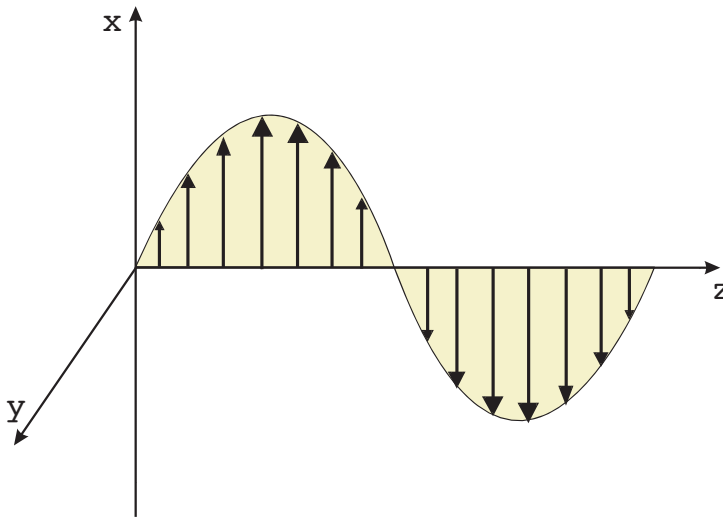

Figure 2: Electrical field in transmission direction 'z'

► Horizontal polarization

With horizontal polarization, the electrical field runs parallel to the earth's surface. The magnetic field runs perpendicular to the electrical field in transmission direction 'z' - that is, perpendicular to the earth's surface.

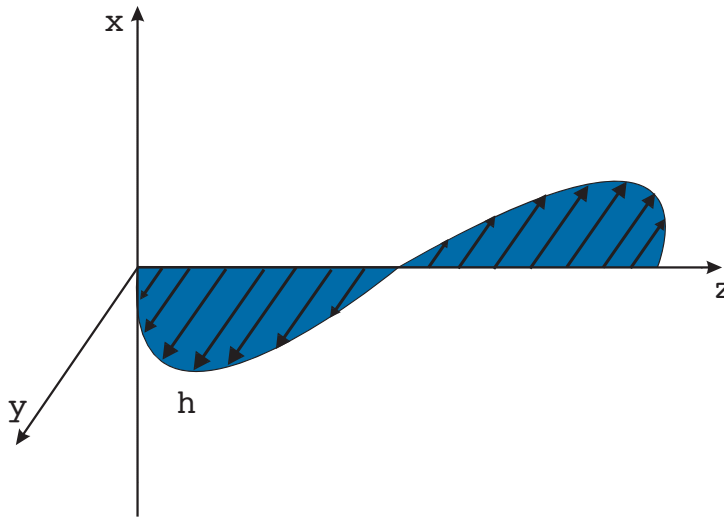

Figure 3: Electrical field in transmission direction 'z'

■ Interpreting antenna diagrams

The antenna diagrams used in this document show the directional characteristic of the relevant antenna in horizontal and vertical cross-sections.

When interpreting antenna diagrams, note the following:

- ▶ Antenna diagrams only specify relative outputs.
- ▶ The relative output of the antenna depends on the observed angle.
- ▶ The maximum output of an antenna is standardized to 0 dB in the antenna diagram.
- ▶ Angles in the antenna diagram with 0 dB are known as main lobes.
- ▶ Angles in the antenna diagram with less than 0 dB are known as side lobes.
- ▶ The antenna diagram does not tell you anything about the absolute output of the antenna nor about the range of the antenna nor the antenna gain.

The following is an example of an interpretation of antenna diagrams:

Omni-directional antenna, horizontal cross-section, antenna viewed from above

Omni-directional antenna, vertical cross-section, antenna viewed from the side

in all angles ca. 0 dB

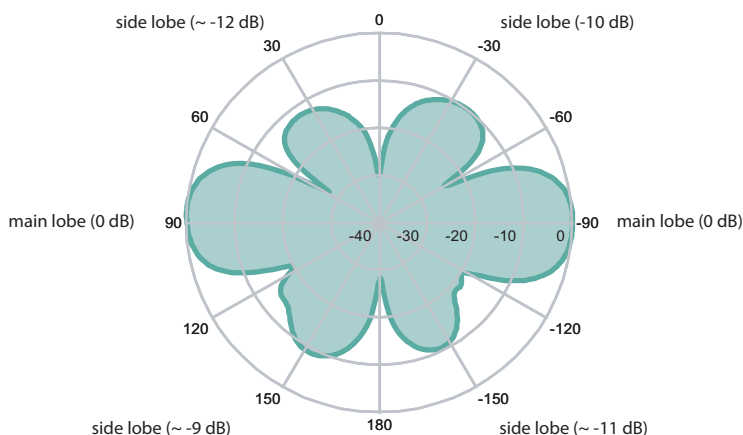
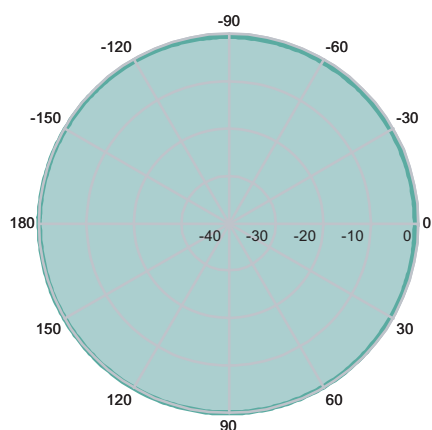

Table 72: Interpreting antenna diagrams

Decibels (dB)

The remaining output of an antenna at a specific angle is shown in negative decibels (dB) on the antenna diagram.

See “Interpreting antenna diagrams” on page 64.

How do you interpret the negative decibel values on the antenna diagram?

Definition dB: $Q_{(P)} = 10 \times \lg_{10} P_1/P_2$ dB

The following table shows the attenuation in steps of -3 dB:

Attenuation in decibels	Remaining output
-3	1/2
-6	1/4
-9	1/8
-12	1/16

In antenna diagrams, circles are used to display the attenuation – usually in steps of 10:

Attenuation in decibels	Remaining output
-10	1/10
-20	1/100
-30	1/1000
-40	1/10 000

Example:

The above antenna diagram shows the output at -30° as -10 decibels.

See “Interpreting antenna diagrams” on page 64.

This means that the antenna transmits 1/10 of the maximum output at an angle of -30° .

Example:

The above antenna diagram shows the output at 150° as -9 decibels.

See “Interpreting antenna diagrams” on page 64.

This means that the antenna transmits 1/8 of the maximum output at an angle of 150° .

C Index

A	
ATEX zone II	61
F	
FAQ	67
R	
Radiating cable	51
T	
Technical Questions	67
Training Courses	67

D Further Support

■ Technical Questions

For technical questions, please contact any Hirschmann dealer in your area or Hirschmann directly.

You will find the addresses of our partners on the Internet at <http://www.hirschmann.com>

Contact our support at <https://hirschmann-support.belden.eu.com>

You can contact us

in the EMEA region at

- ▶ Tel.: +49 (0)1805 14-1538
- ▶ E-mail: hac.support@belden.com

in the America region at

- ▶ Tel.: +1 (717) 217-2270
- ▶ E-mail: inet-support.us@belden.com

in the Asia-Pacific region at

- ▶ Tel.: +65 6854 9860
- ▶ E-mail: inet-ap@belden.com

■ Hirschmann Competence Center

The Hirschmann Competence Center is ahead of its competitors:

- ▶ Consulting incorporates comprehensive technical advice, from system evaluation through network planning to project planning.
- ▶ Training offers you an introduction to the basics, product briefing and user training with certification.

The current technology and product training courses can be found at <http://www.hicomcenter.com>

- ▶ Support ranges from the first installation through the standby service to maintenance concepts.

With the Hirschmann Competence Center, you have decided against making any compromises. Our client-customized package leaves you free to choose the service components you want to use.

Internet:

<http://www.hicomcenter.com>



HIRSCHMANN

A **BELDEN** BRAND