



Product information
RKC 30 - RKC 50 - RKC 40/9
11219

Name	
RKC 30 - RKC 50	
	
Field attachable connector, 7/8" female connector, straight version, with threaded joint, assembling with screw terminals, 4 poles, screwed cable gland with PG 9 thread.	
Delivery informations	
Availability	available
Product description	
Type	RKC 40/9
Order No.	11219
Description	Field attachable connector, 7/8" female connector, straight version, with threaded joint, assembling with screw terminals, 4 poles, screwed cable gland with PG 9 thread.
Number of contacts	4
Color of housing	black
Product characteristics	Oil resistance
Mechanical data	
Type of plug-in contact	Female connector
Design of housing	straight
Thread	7/8"
Design of electrical connection	screw connection
LED display present	✘
Screw joint for cable for external cable diameter	6.0 mm ... 8.0 mm
Screwed cable gland, connecting thread	Pg9
Environmental conditions	
Environmental temperature	-40 °C ... 90 °C
Degree of protection (IP), mounted	IP67
Pollution degree	3
Materials	
Housing material / Molded body	PA
Contact bearer material	TPU, self-extinguishing
Contact material	CuZn
Contact material - Surface refinement	silver-plated and gold-plated
Knurled screw / nut material	Al anodized
Sealing material	NBR
Electrical data	
Contact resistance	≤ 5 mΩ
Rated current In	9 A at 40°C, UL and notice derating
Nominal voltage	240 V
Rated voltage	250 V
Test voltage	1.5 kV eff./60 s
Insulation resistance	> 1 GΩ
Approvals	
Approvals	UL
RoHS 2002/95/EG compliant	RoHS 2002/95/EG

The information published has been compiled as carefully as possible. It is subject to alteration without notice in technical as well as in price related/commercial respect.



Picture
Drawing

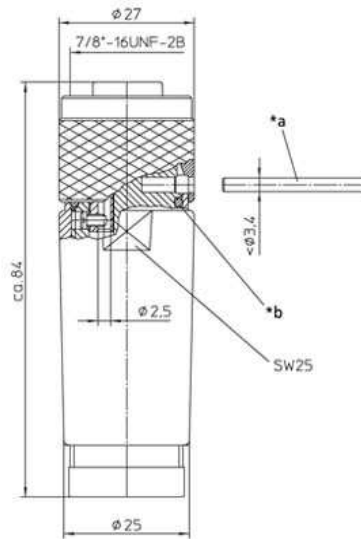

- *a Stift oder Schraubendreher als Montagehilfe
pin or screwdriver as assembly tool
- *b O-Ring
O-ring