



Product information
RKC 30 - RKC 50 - RKC 50/9
11225

Name		RKC 30 - RKC 50
		
		Field attachable connector, 7/8" female connector, straight version, with threaded joint, assembling with screw terminals, 5 poles, screwed cable gland with PG 9 thread.
Delivery informations		
Availability	available	
Product description		
Type	RKC 50/9	
Order No.	11225	
Description	Field attachable connector, 7/8" female connector, straight version, with threaded joint, assembling with screw terminals, 5 poles, screwed cable gland with PG 9 thread.	
Number of contacts	5	
Color of housing	black	
Product characteristics	Oil resistance	
Mechanical data		
Type of plug-in contact	Female connector	
Design of housing	straight	
Thread	7/8"	
Design of electrical connection	screw connection	
LED display present	✘	
Screw joint for cable for external cable diameter	6.0 mm ... 8.0 mm	
Screwed cable gland, connecting thread	Pg9	
Environmental conditions		
Environmental temperature	-40 °C ... 90 °C	
Degree of protection (IP), mounted	IP67	
Pollution degree	3	
Materials		
Housing material / Molded body	PA	
Contact bearer material	TPU, self-extinguishing	
Contact material	CuZn	
Contact material - Surface refinement	silver-plated and gold-plated	
Knurled screw / nut material	Al anodized	
Sealing material	NBR	
Electrical data		
Contact resistance	≤ 5 mΩ	
Rated current In	9 A at 40°C, UL and notice derating	
Nominal voltage	240 V	
Rated voltage	250 V	
Test voltage	1.5 kV eff./60 s	
Insulation resistance	> 1 GΩ	
Approvals		
Approvals	UL	
RoHS 2002/95/EG compliant	RoHS 2002/95/EG	

The information published has been compiled as carefully as possible. It is subject to alteration without notice in technical as well as in price related/commercial respect.



Picture
Drawing

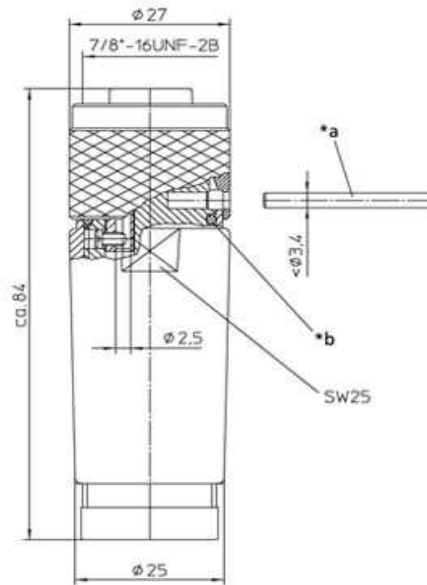

- *a Stift oder Schraubendreher als Montagehilfe
pin or screwdriver as assembly tool
- *b O-Ring
O-ring