



**Product information**  
**RST-RKMW/LED - RST 3-RKMW/LED**  
**A 3-224/2 M**  
**14687**

Name	
RST-RKMW/LED	
	
Cordset, double ended, for sensors and actuators, M12 male connector with self-locking threaded joint, straight, 3-poles, M8 female connector with snap-in joint, angled, 3-poles, LED operation and function indicator (pnp), PUR jacket, halogen free, black,	
Delivery informations	
Availability	available
Product description	
Type	RST 3-RKMW/LED A 3-224/2 M
Order No.	14687
Description	Cordset, double ended, for sensors and actuators, M12 male connector with self-locking threaded joint, straight, 3-poles, M8 female connector with snap-in joint, angled, 3-poles, LED operation and function indicator (pnp), PUR jacket, halogen free, black,
Note	The application of these products in harsh environments should always be checked before use.
Number of contacts	3
Color of housing	black translucent
Color of Housing, side 2	black translucent
Product characteristics	Vibration resistance, Drag chains, Oil resistance
Classification	
Belden brand	Lumberg-Automation
Mechanical data	
Type of plug-in contact	Male connector
Type of plug-in contact, side 2	Female connector
Design of housing	straight
Design of housing, side 2	angled
Thread	M12
Thread, side 2	M8
Design of electrical connection	connector M12
Design of electrical connection, side 2	connector M8
Coding of the M12 round plug connector	A
LED display present	✔
Environmental conditions	
Environmental temperature	-25 °C ... 80 °C
Degree of protection (IP), mounted	IP65
Pollution degree	3
Materials	
Housing material / Molded body	TPU
Housing material / Molded body, side 2	TPU
Contact bearer material	TPU
Contact bearer material, side 2	PA/TPU
Contact material	CuZn
Contact material - Surface refinement	pre-nickeled and 0.3 microns gold-plated
Contact material, side 2	CuZn
Contact material - Surface refinement, side 2	pre-nickeled and 0.3 microns gold-plated
Electrical data	
Rated current In	4 A at 40°C
Nominal voltage	10 - 30 V DC
Rated voltage	32 V

The information published has been compiled as carefully as possible. It is subject to alteration without notice in technical as well as in price related/commercial respect.



Test voltage	1.5 (nur RST) kV eff./60 s
Insulation resistance	> 1 GΩ
<b>Approvals</b>	
Approvals	UL
RoHS 2002/95/EG compliant	yes
<b>Cable</b>	
Cable length	2 m
Cable number	224
Cable description	Cable for sensors and actuators
Color of jacket	black
Material of outer jacket	PUR
Without halogens as in EN 50267-2-3	✓
shielded	✗
welding spark proof	✗
Outer diameter of the cable	4.3 mm
Number of conductors	3
Cable design	3 x 0.34 mm <sup>2</sup>
Conductor design	43 x 0.10 mm
Flame resistant according to standard	yes

**Picture**  
Drawing

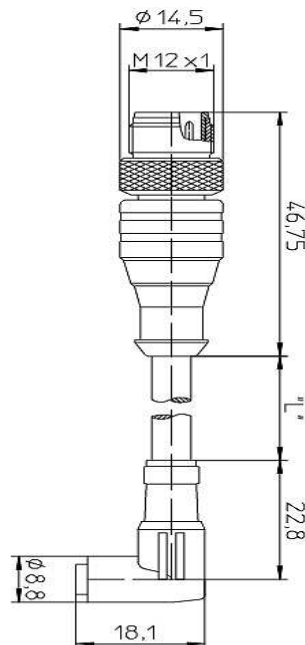

The information published has been compiled as carefully as possible. It is subject to alteration without notice in technical as well as in price related/commercial respect.