



Product information
RKMV - RKMV 4-225/10 M
18215

Name	RKMV
	
	Cordsets, single-ended, for actuator/sensors and distribution boxes, M8 female connector, straight, with self-locking threaded joint and molded cable, 4 poles, PUR jacket, halogen free, black, 10 meters.
Delivery informations	
Availability	available
Product description	
Type	RKMV 4-225/10 M
Order No.	18215
Description	Cordsets, single-ended, for actuator/sensors and distribution boxes, M8 female connector, straight, with self-locking threaded joint and molded cable, 4 poles, PUR jacket, halogen free, black, 10 meters.
Note	The application of these products in harsh environments should always be checked before use.
Number of contacts	4
Color of housing	black translucent
Product characteristics	Vibration resistance, Drag chains, Oil resistance
Classification	
Belden brand	Lumberg-Automation
Mechanical data	
Type of plug-in contact	Female connector
Design of housing	straight
Thread	M8
Design of electrical connection	connector M8
LED display present	✘
Environmental conditions	
Environmental temperature	-40 °C ... 90 °C
Degree of protection (IP), mounted	IP67 / IP69K
Pollution degree	3
Materials	
Housing material / Molded body	TPU
Contact bearer material	PA/TPU
Contact material	CuZn
Contact material - Surface refinement	pre-nickelated and 0.8 microns gold-plated
Knurled screw / nut material	CuZn, nickel-plated
Sealing material	FKM
Electrical data	
Contact resistance	≤ 5 mΩ
Rated current I_n	4 A at 40°C
Nominal voltage	30 V
Rated voltage	36 V
Test voltage	0.8 kV eff./60 s
Insulation resistance	> 1 GΩ
Approvals	
Approvals	UL
Cable	
Cable length	10 m

The information published has been compiled as carefully as possible. It is subject to alteration without notice in technical as well as in price related/commercial respect.



Cable number	225
Cable description	Cable for sensors and actuators
Color of jacket	black
Material of outer jacket	PUR
Without halogens as in EN 50267-2-3	✓
shielded	✗
welding spark proof	✗
Outer diameter of the cable	4.7 mm
Number of conductors	4
Cable design	4 x 0.34 mm ²
Conductor design	43 x 0.10 mm
Flame resistant according to standard	yes

Picture
Drawing

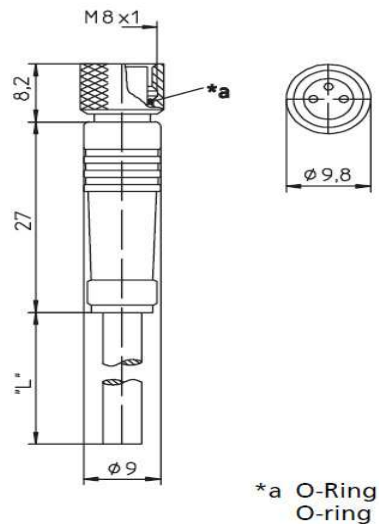

*a O-Ring
O-ring

**4-polig
4 poles**



- 1 = braun / brown
- 2 = weiß / white
- 3 = blau / blue
- 4 = schwarz / black