

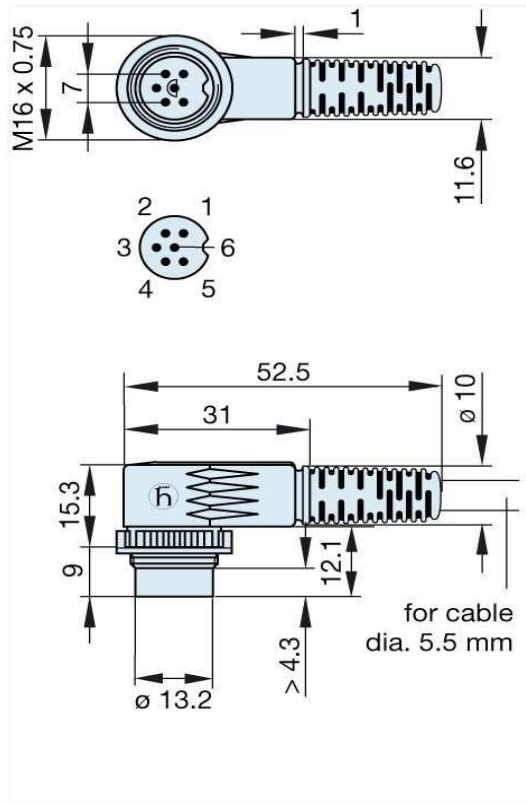

Product information
MAWI 6100 grau/grey
932 910-117

Name	
MAWI 6100 grau/grey	
	
angled plug with locking screw; solder joint	
Delivery informations	
Availability	available
Product description	
Type	MAWI 6100 grau/grey
Order No.	932 910-117
Type of contact	male
Description	angled plug with locking screw; solder joint
Housing Color	grey
Number of contacts	6
Conductor size	$\leq 0.34 \text{ mm}^2$
Technical data	
LF output "Phone"	EN 60 130-09
Pole arrangement DIN	DIN 45 322
Rated current	4 A
Rated voltage	AC/DC 34 V
Cable diameter	6.5 mm
Type of termination	solder
Material	
Contact material	brass
Contact surface material	tin plated
Contact bearer material	PA 66/UL standard 94V-2
Housing material	PE
Environmental conditions	
Protection class (IEC 60529)	IP 30
Temperature range	-20 °C to +60 °C
Scope of delivery and accessories	
Packaging	retail package, polyethylene bag

Picture
Drawing



The information published has been compiled as carefully as possible. It is subject to alteration without notice in technical as well as in price related/commercial respect.