

FB-6SP - Device coupler

2316307

<https://www.phoenixcontact.com/gb/products/2316307>

Please be informed that the data shown in this PDF document is generated from our online catalog. Please find the complete data in the user documentation. Our general terms of use for downloads are valid.

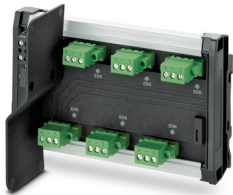

Device coupler for Foundation Fieldbus and PROFIBUS PA with terminal connections for six spurs connected to fieldbus end devices.

Your advantages

- Terminator preinstalled
- Provides current limiting short-circuit protection per spur
- Ex nA [nL, Ex nA [ic] or FISCO ic spur connections
- Connect up to 6 Foundation Fieldbus or PROFIBUS PA field devices
- Single-sided plug configuration eliminates cable bend radius issues

Commercial data

Item number	2316307
Packing unit	1 pc
Minimum order quantity	1 pc
Sales key	DNC144
Product key	DNC144
Catalog page	Page 456 (C-6-2019)
GTIN	4046356883580
Weight per piece (including packing)	322.5 g
Weight per piece (excluding packing)	322.5 g
Customs tariff number	85369095
Country of origin	US

FB-6SP - Device coupler



2316307

<https://www.phoenixcontact.com/gb/products/2316307>

Technical data

Notes

Utilization restriction

EMC note	EMC: class A product, see manufacturer's declaration in the download area
----------	---

Product properties

Product type	Device coupler
MTTF	1256 Years (25 degrees C)

Electrical properties

Supply

Supply voltage range	10.5 V DC ... 32 V DC (input on trunk line side)
Typical current consumption	4.8 mA

Connection data

Supply

Conductor cross section, flexible	2.50 mm ² ... 0.20 mm ²
Conductor cross section, rigid	2.50 mm ² ... 0.20 mm ²
Conductor cross section, flexible [AWG]	24 ... 12
Conductor cross section AWG	24 ... 12

Ex data

Safety data

Input voltage U_i	32 V (IIB (C/D))
	24 V (IIC (A/B))
	17.5 V (FISCO)
Inductance L_i	4 μ H
Capacitance C_i	0 μ F
Max. output voltage U_o	U_{in} (spur)
Max. output current I_o	56 mA (spur)
Max. output power P_o	1.792 W
Current consumption	4.8 mA (Maximum, no load)
	0.34 A (maximum trunk current)
IIC/IIB (spur): Max. external inductivity L_o / Max. external capacitance C_o	/ 80 nF
	0.26 mH

Interfaces

Signal	FOUNDATION Fieldbus
	PROFIBUS

Data: Foundation Fieldbus and PROFIBUS PA Segment

FB-6SP - Device coupler

2316307

<https://www.phoenixcontact.com/gb/products/2316307>

Connection method	Pluggable COMBICON screw connection for each spur
No. of channels	6
Termination resistor	100 Ω, external removable plug included 100 Ω (external removable plug)
Conductor cross section flexible max.	2.5 mm ²
Conductor cross section flexible min.	0.2 mm ²
Conductor cross section, rigid max.	2.5 mm ²
Conductor cross section, rigid min.	0.2 mm ²
Conductor cross section AWG max.	12
Conductor cross section AWG min.	24
Output nominal voltage	≤ 32 V (each spur)
Output current	38 mA

Dimensions

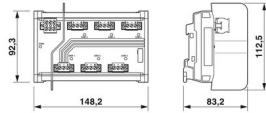
Dimensional drawing	
Width	148.2 mm
Height	112.5 mm
Depth	83.5 mm

Material specifications

Flammability rating according to UL 94	V0
--	----

Environmental and real-life conditions

Ambient conditions

Degree of protection	IP20
Ambient temperature (operation)	-50 °C ... 90 °C
Ambient temperature (storage/transport)	-50 °C ... 90 °C
Altitude	2000 m
Max. permissible relative humidity (operation)	< 95 % (non-condensing)
Permissible humidity (operation)	5 % ... 95 % (non-condensing)
Permissible humidity (storage/transport)	5 % ... 95 % (non-condensing)
Shock	30g, 11 ms
Vibration (operation)	5g, 10 Hz ... 150 Hz

Approvals

ATEX

Identification	⊕ II 3(3)G Ex nA [ic] IIC T4 Gc, Entity/FISCO ic spurs Ex nA [nL] IIC T4 Gc Ex ic IIC T4 Gc, FISCO ic
Certificate	Sira 13ATEX4247X

IECEX

Identification	Ex nA [ic] IIC T4 Gc, Entity/FISCO ic spurs
	Ex nA [nL] IIC T4 Gc
	Ex ic IIC T4 Gc, FISCO ic
Certificate	IECEX SIR 13.0089X

CSA, USA/Canada

Identification	Class I, Div. 2, Groups A, B, C, D
	Ex nA [nL] IIC T4 Gc
	Class I, Zone 2, AEx nA [nC] IIC T4 Gc

UL, USA

Identification	Class I, Zone 2
	AEx nA [ic] IIC T4, Entity/FISCO spurs
	Ex nA [ic] IIC T4 Gc
	Class I, Div. 2, Groups A, B, C, D T4

UKCA Ex (UKEX)

Identification	Ⓢ II 3(3)G Ex nA [ic] IIC T4 Gc, Entity/FISCO ic spurs
	Ex nA [nL] IIC T4 Gc
	Ex ic IIC T4 Gc, FISCO ic
Certificate	PxCAI22UKEx2316307X

CCC

Identification	Ex ec [ic] IIC T4 Gc
	Ex ic IIC T4 Gc

Standards and regulations

Standards

Standards/regulations	EN 60079-0:2011, EN 60079-11:2012, EN 60079-15:2005, EN 60079-15:2010
	IEC 60079-0:2011, IEC 60079-11:2011, IEC 60079-15:2005, IEC 60079-15:2010

Standards/regulations

Standards/regulations	Ring wave noise immunity in acc. with IEC 61000-4-12
-----------------------	--

Standards/regulations

Standards/regulations	Dry heat in acc. with IEC 61131-2
-----------------------	-----------------------------------

Standards/regulations

Standards/regulations	Damp heat in acc. with IEC 61131-2
-----------------------	------------------------------------

Standards/regulations

Standards/regulations	Shock and vibration in acc. with EN 61131-2 and EN 50178
Standards/regulations	IEC 61158-2

FB-6SP - Device coupler

2316307

<https://www.phoenixcontact.com/gb/products/2316307>



Mounting

Mounting position

On horizontal and vertical DIN rail NS 35 in acc. with EN 60715

FB-6SP - Device coupler

2316307

<https://www.phoenixcontact.com/gb/products/2316307>

Drawings

Dimensional drawing

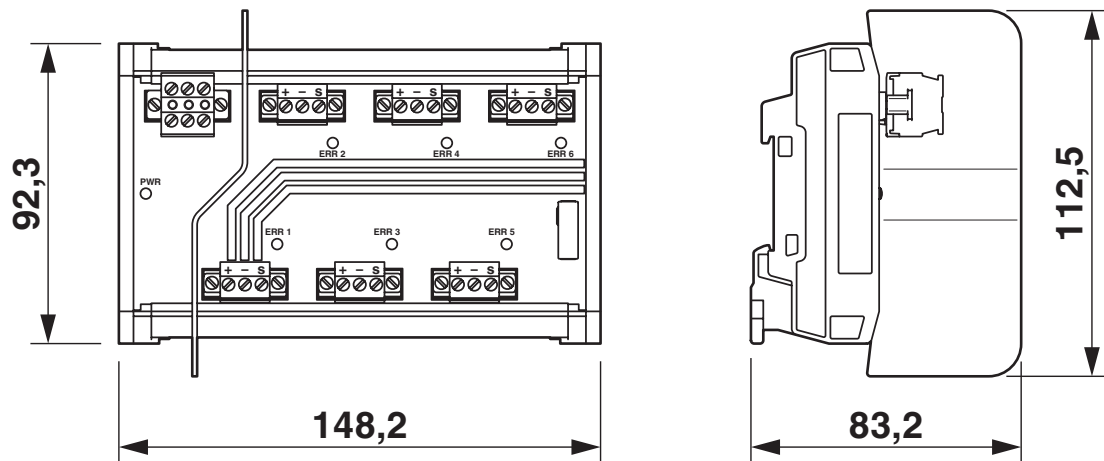

FB-6SP dimensions

Circuit diagram

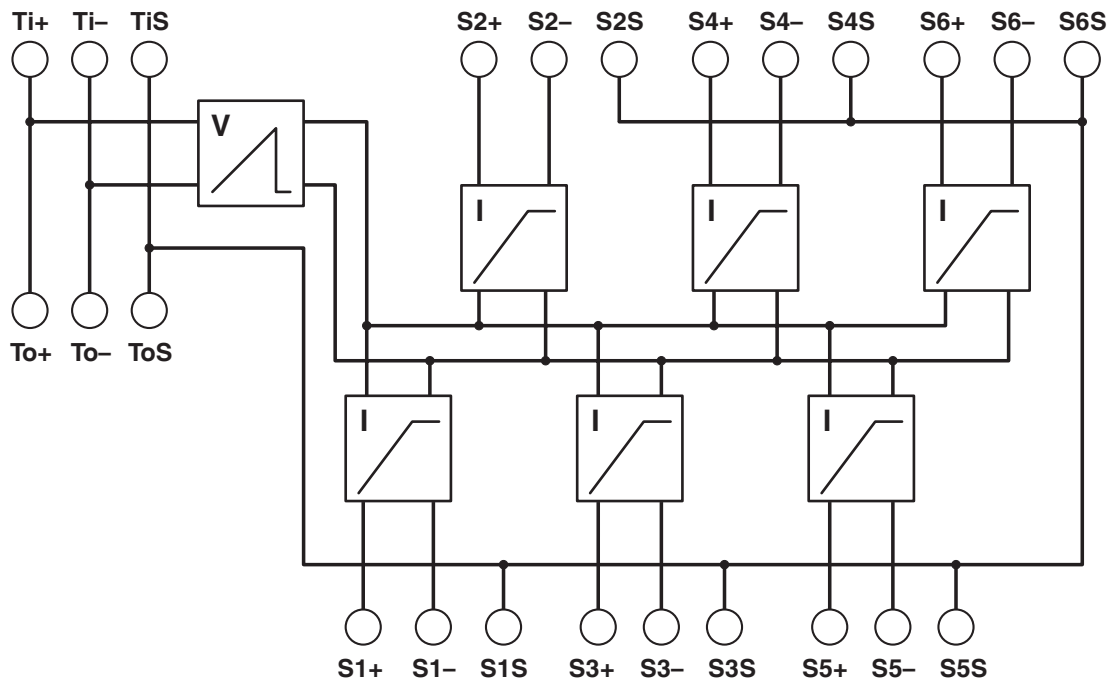

FB-6SP - Device coupler





2316307

<https://www.phoenixcontact.com/gb/products/2316307>

Approvals

To download certificates, visit the product detail page: <https://www.phoenixcontact.com/gb/products/2316307>

 **UL Listed**
Approval ID: FILE E 330267

 **cUL Listed**
Approval ID: FILE E 330267

 **CSA**
Approval ID: 2673619

 **cUL Listed**
Approval ID: FILE E 199827

 **UL Listed**
Approval ID: FILE E 199827

 **CSAus**
Approval ID: 2673619

 **CCC**
Approval ID: 2022122310115623

 **IECEx**
Approval ID: IECEx SIR 13.0089X

 **ATEX**
Approval ID: SIRA 13 ATEX 4247X

cULus Listed

cULus Listed

cCSAus

FB-6SP - Device coupler

2316307

<https://www.phoenixcontact.com/gb/products/2316307>



FB-6SP - Device coupler



2316307

<https://www.phoenixcontact.com/gb/products/2316307>

Classifications

ECLASS

ECLASS-11.0	27242610
ECLASS-12.0	27242610
ECLASS-13.0	27242610

ETIM

ETIM 8.0	EC001600
----------	----------

UNSPSC

UNSPSC 21.0	32151600
-------------	----------

FB-6SP - Device coupler

2316307

<https://www.phoenixcontact.com/gb/products/2316307>



Environmental product compliance

REACH SVHC	Lead 7439-92-1
China RoHS	Environmentally Friendly Use Period = 50 years
	For information on hazardous substances, refer to the manufacturer's declaration available under "Downloads"

FB-6SP - Device coupler

2316307

<https://www.phoenixcontact.com/gb/products/2316307>



Accessories

FB-PS-PLUG-24DC/28DC/0.5/EX - Power module

2316132

<https://www.phoenixcontact.com/gb/products/2316132>



Power supply plug for fieldbus system in hazardous locations. Provides 500 mA @ 28 V DC to couplers along the trunk.

FB-PS-MB-25DSUB/EX - Power supply unit

2316146

<https://www.phoenixcontact.com/gb/products/2316146>



Four-channel, redundant fieldbus power supply base. Host connection is a D-SUB 25 socket connector.

FB-6SP - Device coupler

2316307

<https://www.phoenixcontact.com/gb/products/2316307>



FB-PS-MB-Y/EX - Power supply unit

2316148

<https://www.phoenixcontact.com/gb/products/2316148>

Four-channel redundant fieldbus power supply base. Host connections are for two Yokogawa AKB336 20-pin cables.



FB-PS-MB-I/EX - Power supply unit

2316149

<https://www.phoenixcontact.com/gb/products/2316149>

Four-channel, redundant fieldbus power supply base. Host connection is for an Invensys® D-SUB 25 cable.



FB-6SP - Device coupler

2316307

<https://www.phoenixcontact.com/gb/products/2316307>



FB-PS-BASE/EX - Power distributor

2316145

<https://www.phoenixcontact.com/gb/products/2316145>



Base for fieldbus power supply plugs. Provides redundancy when 2 plugs are installed. Redundancy is maintained across multiple bases via internal power buses. Additional internal bus provides remote indication.

PT 2X2-FF-ST - Surge protection plug

2800755

<https://www.phoenixcontact.com/gb/products/2800755>



PLUGTRAB, plug-in surge protection for Foundation Fieldbus

FB-6SP - Device coupler

2316307

<https://www.phoenixcontact.com/gb/products/2316307>



PT 4+F-BE - Surge protection base-element

2839415

<https://www.phoenixcontact.com/gb/products/2839415>

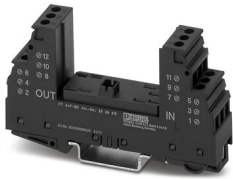

Base element for protective plug PT with protective circuit for a 4-wire floating signal circuit, gas-filled surge arrester between the connections 3-4 (GND) and 9-10, for mounting on NS 35/7.5 and NS35/15, housing width: 17.5 mm

FB1-S1-6SP-S-0-10-00-0-0 - Junction box

2316446

<https://www.phoenixcontact.com/gb/products/2316446>



Stainless steel field junction box with ten ports for use in hazardous locations. Includes six-spur block device coupler (FB-6SP) for Foundation Fieldbus or PROFIBUS PA, Trunk cable (+, -, S) is connected to a Plugrab surge base (PT 4+F-BE)

FB-6SP - Device coupler

2316307

<https://www.phoenixcontact.com/gb/products/2316307>



FB1-S1-6SP-T-0-10-00-0-0 - Junction box

2316420

<https://www.phoenixcontact.com/gb/products/2316420>



Stainless steel field junction box with ten ports for use in hazardous locations. Includes six-spur block device coupler (FB-6SP) for Foundation Fieldbus or PROFIBUS PA, three terminal blocks for trunk cable connection (+, -, S).

FIELDBUS TERMINATOR - Termination resistor

2316034

<https://www.phoenixcontact.com/gb/products/2316034>

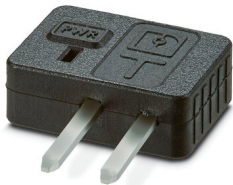

The fieldbus terminator plug is pre-installed in the trunk out connection of device couplers.

Phoenix Contact 2023 © - all rights reserved
<https://www.phoenixcontact.com>

PHOENIX CONTACT Ltd
Halesfield 13, Telford
Shropshire, TF7 4PG
01952 681700
info@phoenixcontact.co.uk